



DU8055Z
DU8053Z
DU8057Z
DK8155Z
DK8150Z

User Manual

Table of Contents

| | |
|---|----|
| Copyright..... | 3 |
| Copyright | 3 |
| Disclaimer..... | 3 |
| About the Manual | 3 |
| Important Safety Guidelines | 4 |
| Safety Notification | 4 |
| Risk Group 3 Laser Hazard | 5 |
| Light Hazard Warning..... | 5 |
| Light Intensity Hazard Distance | 5 |
| Restriction Zone..... | 6 |
| Disposal of Old Electric and Electronic Equipment | 8 |
| Important Recycling Instructions | 8 |
| Introduction..... | 9 |
| Packing Checklist | 9 |
| Projector Overview..... | 10 |
| IO Panel | 12 |
| Control Panel | 13 |
| Remote Control..... | 14 |
| Installation and Setting up | 16 |
| Inserting or Changing the Remote Control Batteries..... | 16 |
| Installing the Projector | 17 |
| Precautions for Installation | 17 |
| Mounting the Projector..... | 18 |
| Installing or Removing the Optional Lens | 19 |
| Connecting to AC Power Supply | 21 |
| Turning On the Projector | 21 |
| Turning Off the Projector..... | 22 |
| Adjusting the Projection Mode..... | 23 |
| Adjusting the Projected Image Position | 24 |
| Adjusting the Focus and Zoom | 24 |
| Adjusting Geometric Distortion | 25 |
| Keystone | 25 |
| 4 Corner | 26 |
| Pincushion / Barrel | 29 |
| Custom Warp..... | 30 |
| Using Control ID for Multi-Projector Application..... | 31 |
| Using the Constant Brightness Function to Maintain the Brightness Output..... | 33 |
| Connecting Equipment..... | 34 |
| Connecting a Computer..... | 34 |
| Connecting a Video Device | 34 |
| Connecting to a Control Equipment | 35 |
| Connecting a Screen Trigger | 36 |
| Connecting an HDBaseT Transmitter..... | 37 |
| Using the Projector..... | 38 |
| Using On-Screen Display..... | 38 |
| Using the On-Screen Display | 38 |
| Menu Tree..... | 39 |
| OSD Menu – INPUT | 45 |
| OSD Menu – PICTURE..... | 48 |

| | |
|-------------------------------------|----|
| OSG Menu – ALIGNMENT | 50 |
| OSD Menu – CONTROL | 54 |
| OSD Menu – SETTINGS | 57 |
| OSD Menu – INFO..... | 59 |
| Product Specification | 60 |
| Supported Signal Input Timing | 62 |
| Configurations of Terminals | 66 |
| Lens Series..... | 67 |
| Product Dimensions | 68 |
| LED Indication | 69 |
| Common Problems and Solutions..... | 70 |
| About the Vivitek Support | 72 |

Copyright

Copyright

The User's Manual (including all pictures, illustrations and software) is protected by the international copyright law. All rights are reserved. No duplication of the manual or any content included in the manual is allowed without the written consent of the manufacturer.

©2024 Vivitek. Vivitek is a trademark of Delta Electronics, Inc. ©All rights reserved. 2024

Disclaimer

The information in the manual is subject to change without notice. The manufacturer does not provide any statement or warranty of the contents in the manual and clearly give up the implied warranties of merchantability and of fitness for a particular purpose. The manufacturer reserves the rights to modify the publication and change the contents of the materials at any time without notice to any person.

About the Manual

The manual describes how to install and use the projector and is applicable to the purchaser of this projector. Relevant information (such as illustrations and descriptions) is put on the same page and accurate as much as possible the format, easy for printing, is convenient for reading and paper-saving which is beneficial to environmental protection. It is suggested to print only the page you need.

Important Safety Guidelines

Thank you for purchasing this high quality product!

Read the Manual carefully to obtain the best performance. The Manual provides instructions on how to use the menu and implement the operation.

Safety Notification

CAUTION To turn off the main power, ensure to unplug from the power outlet.



CAUTION To prevent electric shock, do not open the cabinet. There are high-voltage components inside. Refer service to qualified service personnel.



CAUTION The symbol warns the user about electric shock caused by voltage not insulated. Therefore, it is dangerous to make any kind of contact with any parts inside the projector.



CAUTION To prevent the projector from electrical discharge or electric shock, do not expose the projector to rain or moist environment. Do not use the plug with an extension cord or an outlet unless all the prongs can be fully inserted.



This symbol alerts the user that important information which should be read carefully to avoid problems concerning the operation and maintenance of the projector.

WARNING TO CALIFORNIA RESIDENTS:

Handling the cables supplied with this equipment might expose user to a little lead, a chemical known to the State of California, resulting in risks of barrenness. Please remember to wash hands after handling.

NOTIFICATION (CANADA)

This Class A digital equipment complies with Canadian ICES-003.

CE NOTIFICATION

This is a Class A product, which complies with rules for CE marking. This product may cause radio interference that the user may be supposed to take adequate measures.

FCC NOTIFICATION

This device complies with part 15 of the FCC Rules. The operation is subject to the following two conditions:

(1) This device may not cause harmful interference.

(2) This device must accept any interference received, including interference that may cause undesired operation. This equipment has been tested and found to comply with part 15 of the FCC Rules. These requirements are designed to provide reasonable protection against harmful interference when the equipment operates in a commercial environment. This equipment might generate radio frequency energy. If user does not install or use in accordance with the instructions in manual, the radio frequency energy may interfere radio reception. If the above scenario occurs, the user may be responsible for correcting the interference.



WARNING!

Changes or modifications without approval from Vivitek could void the user's authorization to operate the product.

Risk Group 3 Laser Hazard

This product is a risk group 3 laser product. It must be installed in a safe place and must be handled by qualified and professionally trained personnel.

Do not attempt to access the internal hardware of the projector. Do not attempt to modify or remove the laser module. Do not operate the projector without its protective covers.

Do not operate the projector without a lens installed.

Please consult with a qualified professional to install or remove the lens.

Light Hazard Warning

The hazard distance is the distance measured from the projection lens at which the intensity or energy per unit of surface is lower than the applicable exposure limit on the cornea or skin¹.

The hazard zone is the area from the rojection lens up to the hazard distance that encompasses where the projected beam is considered hazardous².

If the person is within the hazard distance, the beam is considered unsafe for exposure.

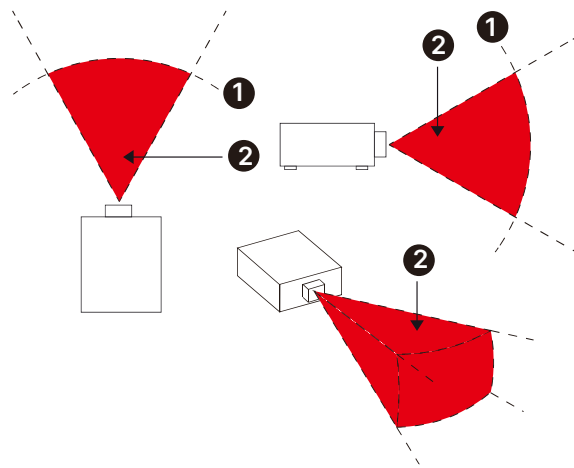

Light Intensity Hazard Distance

| Lens P/N and Specification | (IEC/EN 62471-5) Hazard Distance (m) | | | | | | | |
|----------------------------|--------------------------------------|-------------|-------------|-------------|------------|------------|------------|-------------|
| | D89-UST01 | D89-UWZ01 | D89-UWZ02 | D89-WZ01 | D89-ST01 | D89-SMLZ01 | D88-LOZ101 | D88-LOZ201 |
| | 0.31 ~ 0.33 | 0.55 ~ 0.75 | 0.74 ~ 1.08 | 1.05 ~ 1.41 | 1.4 ~ 2.11 | 2.1 ~ 4.0 | 3.0 ~ 4.52 | 4.46 ~ 6.94 |
| Risk Group | RG2 | RG2 | RG2 | RG2 | RG2 | RG3 | RG3 | RG3 |
| Hazard Distance (HD) | 0 | 0 | 0 | 0 | 0 | 2.5m | 3.1m | 4.3m |



Note:

- Some lens are with Risk Group 3 (RG3). Permanent eye injury is possible when exposed to the high intensity light beam within the hazard distance (HD).
- Never look into the lens directly.
- Installer must control access to the light beam or install projector at a height to prevent eyes exposure within the hazard distance.

Restriction Zone

A restriction zone should be in place around the hazard zone to prevent any person from entering the hazard zone with any part of their body:

Horizontal clearance^①. This should be no less than 2.5m around the hazard zone^②.

Vertical clearance^③. This should be no less than 3m between the hazard zone^② and the floor when the projector is installed overhead.

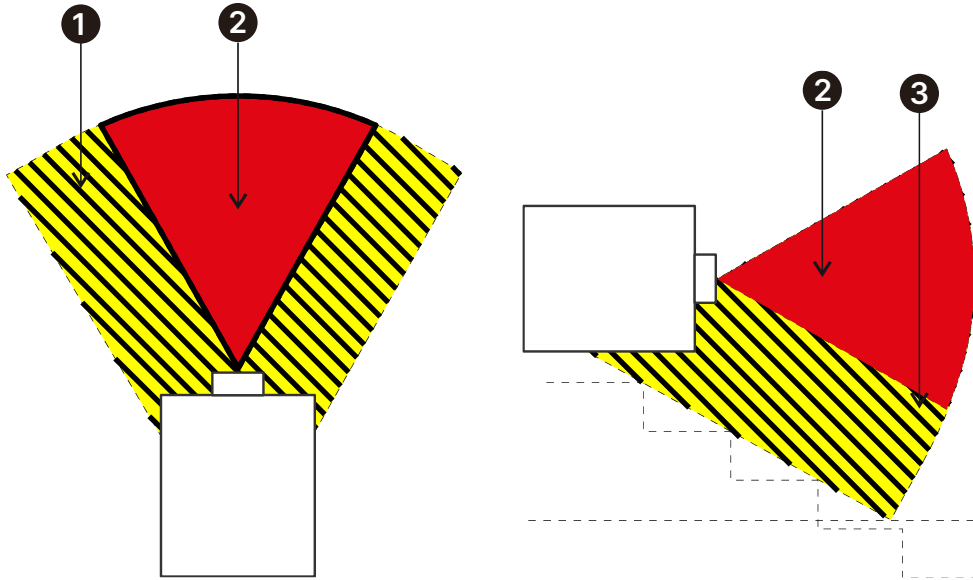

LIGHT MODULE

- A light module containing multiple laser diodes acts as the light source in the product.
- These laser diodes are sealed in the light module. It is recommended to ask dealer for maintenance or repair services of the light module.
- The end user is not allowed to replace the light module.
- Contact distributor who provides the qualified service for light module replacement and further information.

LASER SAFETY NOTIFICATION AND CAUTION



Do not stare at the lens while in use

Product Label

Manufacturer's ID Label, Explanatory Label, Certification Statement Label and Hazard Warning Symbol and Aperture Label

| | | |
|---|--|---|
| <p>Model / Modèle (型號 / 型号) : DU8055Z</p> <p>AC Input / Entrée CA (輸入 / 输入) : 100-240V~ 50/60Hz 11A</p> <p>This device complies with part 15 of the FCC rules. Operation is subject to the following two conditions: (1) this device may not cause harmful interference, and (2) this device must accept any interference received, including interference that may cause undesired operation. CAN ICES-003(A) / NMB-003(A)</p> | <p>DLP Projector / Projecteur DLP (數位投影機/數字投影机)</p> <p>Laito on liitettävä suojakoskettimilla varustettuun pistorasiaan. Apparätet må likkoplas jordat stikkontakt. Apparaten skal anslutas till jordat uttag. Apparätets stikprop skal tilsluttes en stikkontakt med jord, som giver forbindelse til stikproppens jord.</p> <p>Caution : Do not open the cover. No user-serviceable parts inside. Avertissement : ne pas ouvrir le couvercle. Le produit ne contient aucune pièce interne réparable par l'utilisateur.</p> <p>警告：請勿打開外殼，設備內無服務性維修之元件。 警告：請勿打開外殼，設備內無服務性維修之元件。 警告：在居住環境中，運行此設備可能會造成無線干擾。 警告：為避免電磁干擾，本產品不應安裝或用於住宅環境。</p> <p>合格证 Qualified Certificate</p> <p>CE, RoHS, UKCA, FC, etc.</p> | <p>EU Contact address: Delta Electronics(Netherlands)B.V. Zandsteen 15, 2132MZ Hoofddrop, The NetherLands</p> <p>UK Contact address: Delta Electronics(UK) LTD Eltek House Cleveland Road, Hemel Hempstead Industrial Estate, Hemel Hempstead, Hertfordshire, HP2 7EY</p> <p>Serial No. / n° de série: (序號/序号) Code39 (SN) "WDU8054YWWSSSS"</p> <p>M/F Date (製造日期 / 生产日 / 제조시기) : Month Year Made in China / Fabriqué en Chine / 中国製造 / 中國製造 製造商：台达电子管理企业(上海)有限公司</p> |
|---|--|---|

| | |
|--|--|
| | <p>Complies with 21 CFR 1040.10 and 1040.11 except for conformance as a Risk Group 2 LIP as defined in IEC 62471-5:2015. For more information see Laser Notice No. 57, dated May 8, 2019."</p> |
| <p>CAUTION ! Do not stare into the beam</p> <p>RG2 This projector may become RG3 when an interchangeable lens with throw ratio greater than 2.12 is installed.</p> <p>Refer to the manual for the lens list and hazard distance before operation. Such combinations of projector and lens are intended for professional use only, and are not intended for consumer use.</p> | <p>RG2 This projector employing RG2 lens complies with FDA performance standards for laser products except for conformance as a Risk Group 2 LIP as defined in IEC 62471-5: Ed. 1.0. For more information see Laser Notice No. 57, dated May 8, 2019</p> <p>RG3 Warning: No direct exposure to the beam is permitted. Not for household use. This projector employing RG3 lens complies with performance standards for laser product 21 CFR Part 1040 except with respect to those characteristics authorized by Variance Number FDA-2024-4-0726 effective March 08, 2024.</p> |
| <p>CLASS 1 / RG3 雷射產品 警告！請勿直視光源 不允許直接觀看雷射光中 第1類 / RG3 危險距離：參考說明書 不適合家庭使用</p> | <p>CLASS 1 LASER PRODUCT LASERPRODUKT DER KLASSE 1 APPAREIL À LASER DE CLASSE 1 IEC 60825-1 : 2014 IEC/EN 62471-5: 2015</p> |
| <p>RISK GROUP 3 WARNING ! DO NOT LOOK INTO THE BEAM. NO DIRECT EYE EXPOSURE TO THE BEAM IS PERMITTED. HAZARD DISTANCE. REFER TO THE MANUAL.</p> <p>GRUPE DE RISQUE 3 MISE EN GARDE NE PAS REGARDER DIRECTEMENT DANS LE FAISCEAU. L'EXPOSITION DIRECTE DES YEUX AU FAISCEAU EST INTERDITE. DISTANCE À RISQUE. SE REPORTER AU MANUEL.</p> | <p>위험 그룹 3 경고! 빔을 눈으로 보지 마십시오. 빔을 직접 눈에 노출하는 것은 허용되지 않습니다. 위험 거리: 설명서를 참조하십시오.</p> |

| | |
|--|--|
| <p>WARNING : MOUNT ABOVE THE HEADS OF CHILDREN ! Do not look into the beam less than 1m. No direct eye exposure to the beam is permitted.</p> <p>"AVERTISSEMENT-INSTALLER AU-DESSUS DE LA TÊTE DES ENFANTS." Avertissement supplémentaire contre l'exposition oculaire pour des expositions à une distance de moins de 1m.</p> | |
|--|--|

Installation and Use Notices

1. Read and keep this manual properly.
2. Pay attention to all the noted warnings and follow all the guidelines and descriptions in this manual.
3. Do not use the projector near water.
4. Do not install the equipment near the thermal sources, such as heaters, radiators, furnace, amplifiers, and any other equipment that may generate heat.
5. Be careful while holding the equipment or moving the trolley with projector to prevent the equipment from turning over.
6. Notice whether there is any parts with flaws after receiving the projector.
7. Please notice that the projector will not power on until the lens is fitted. The protection covering the lens should be taken to install the lens.
8. Do not let any vent be obstructed.
9. Do not destroy the safety protection function of polarized or grounding plug of the power cord. A polarized plug has one wide and one narrow blade. The plug has two blades and one grounding blade. The wide blade or grounding blade is provided for the safety concerns. If the plug provided does not match the outlet, please contact the electrician to change outlet.
10. The +12V trigger only outputs 12V DC trigger signal. Do not connect other power input or output. Otherwise, the equipment may malfunction.
11. Adjust the slide switch with suitable volt input, and then plug in the projector; the red LED indicator would flash and then stabilize, getting into standby mode. User should only use the connectors or accessories provided by the manufacturer.
12. When user turns on the projector, the red LED indicator would flash until stabilized. Do not look at the lens directly while the projector is running.
13. Unplug the power cord of the equipment if there is a thunderstorm or the equipment is not going to be used for an extended period of time.
14. It is suggested to properly keep the packaging materials for future transportation or afterservice.
15. If any breakdown occurs, please contact dealer or manufacture for qualified repair service.
16. Do not place the projector on flammable materials such as carpet or sponge pads; overheating may cause ignition, fire, or damage to the projector.
17. Do not install the projector in humid, dusty areas or areas where it will come into directly contact with fumes and vapors; these can lead to deterioration of parts, electrical shock, and even deformation of plastic parts.

Disposal of Old Electric and Electronic Equipment

The symbol on your product or the package represents that the product should not be treated as the normal household waste when discarded but should be carried to the recycling location of the waste electric and electronic equipment. The consequence on the environment and human health due to the incorrect disposal of the product can be prevented if it can be ensured that the product is properly discarded. Material recycling is helpful to the protection of natural resources. The symbol is only valid in the European Union. If you want to discard electrical and electronic equipment, contact the governmental authorities or your dealer for the correct method of disposal.

Important Recycling Instructions

The product may contain other electronic wastes and may pose risk if not discarded properly. Abide by the local, state/provincial or federal laws of recycling or discarding. For more information, please visit the website and contact Electronic Industries Alliance (EIA) on WWW.EIAE.ORG.

Introduction

The User's Manual describes the installation, setup and operation of the projector and provides assistance to the installation personnel and the end-user to fully develop the performance of the projector. Vivitek has made every effort to ensure that the information in the Manual is correct at the time of printing. The contents may be frequently updated due to the continuous product improvements and customer feedback.

You can find the latest version of the Manual and the manual of other Vivitek products on www.vivitekcorp.com.

Packing Checklist

The following items are included in the packaging box of the series projector. If there is any loss or damage to any item, contact your dealer or Vivitek customer service department.

Only the appropriate power cable for the destination territory is supplied with the projector.

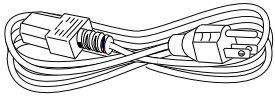

Power Cord-USA 2 pieces
(Note : 125V*1, 220V*1)

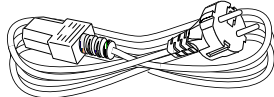

Power cord EU

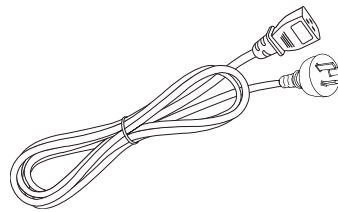

Power cord China

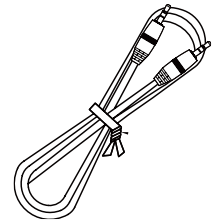

Wired Remote Cable

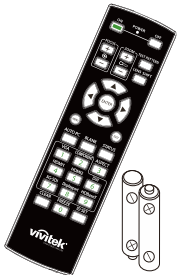

IR Remote Control
and Battery (AA, x2)



Safety Booklet



Warranty Card WW

Projector Overview

Front-left View

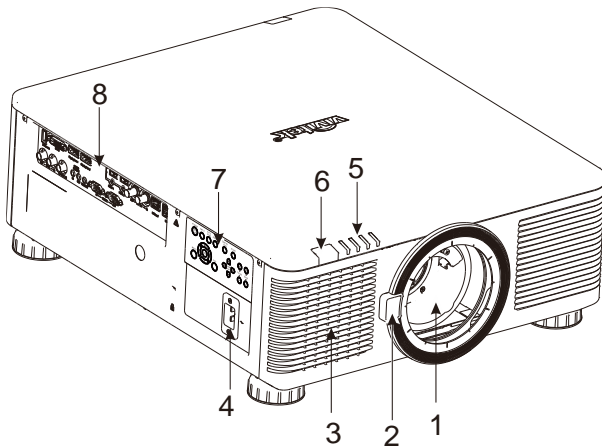

Front-right View

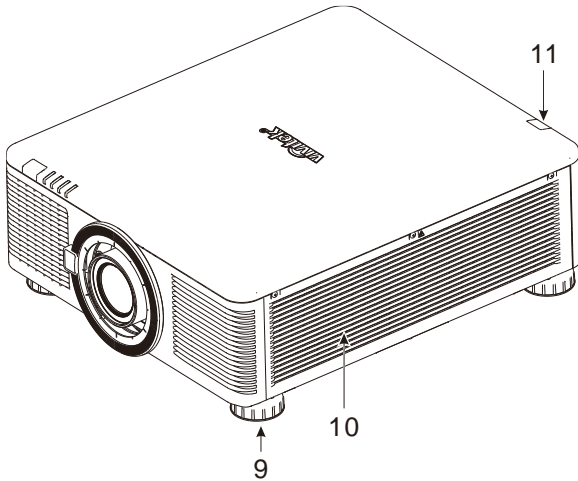

1. **Lens Mounting Hole**
The mounting hole is for installing the projection lens.
2. **Lens Release Button**
Press the Lens Release button before removing the lens.
3. **Air Intake**
The fan pulls the cool air to the projector for system cooling.
4. **AC Inlet**
Connect the supplied power cable to this inlet.
5. **LED Indicator**
Display current projector status such as power, light source status and warning.
6. **Front IR Receiver**
The Receiver is for IR signals from the remote control.
7. **Control Panel**
Press the button to operate the OSD menu or adjust the lens Settings see OSD controls.
8. **I/O Connector Panel**
Connect to various input, control or output terminals to the projector.
9. **Height Adjuster**
Adjust level of projector
10. **Intake Vent**
The fans pull air to cool the radiator of the projector.
11. **Rear IR Receiver**
The Receiver is for IR signals from the remote control.



Important:

Air passes through the projector's grill openings to ensure good air circulation and to keep the projector running smoothly. Do not obstruct any of the grill openings and keep the required distance from any object.

Bottom View

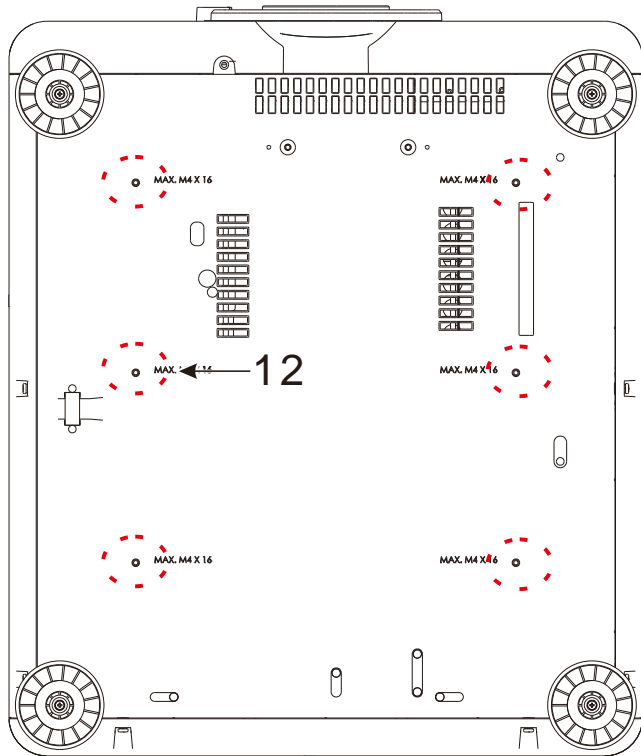

12. Ceiling Mounting Hole

Total, six M4 screw holes with maximum depth of 16mm



Caution:

- When installing, ensure that you use only UL Listed ceiling mounts. Contact your dealer for information on mounting the projector on a ceiling.
- With ceiling installation, use approved mounting hardware & M4 screws; maximum depth of screw is 16 mm.

IO Panel

DU8057Z / DU8055Z / DU8053Z

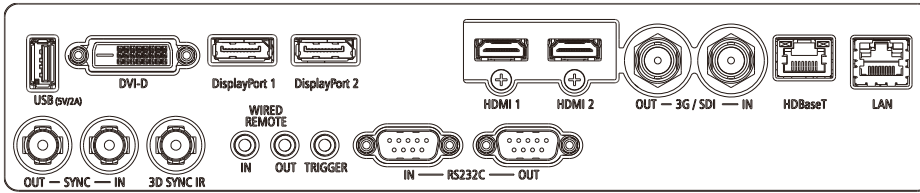

DK8155Z / DK8150Z

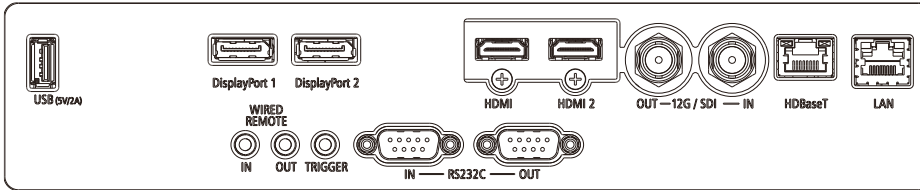

USB 5V-2A

Connect a USB cable for USB host.

Note: Support 5V/2A output as long as the projector Power On.

DVI-D

Connect to DVI-D cable from a DVI-D output of the device.

DisplayPort 1 / 2

Connect a DisplayPort cable to the connector.

HDMI 1 / 2

Connect the HDMI cable from a computer or video device.

3G/SDI IN / OUT

Connect to 3G SDI source.

HDBaseT

Connect the HDBaseT Transmitter.

LAN

Connect an Ethernet cable from a computer, network device.

SYNC IN / OUT

Connect 3D-sync in cable from a computer or an enabled device.

3D SYNC IR

Connect 3D IR glasses receiver unit.

WIRED REMOTE IN / OUT

Connect the supplied remote controller to the projector

TRIGGER (12V +/-1.5V)

When connected to the screen through a 3.5mm cable, the screen deploys automatically on startup of the projector. The screen reacts when the projector is powered off.

RS-232 IN / OUT

The 9-pin D-sub interface is used to connect to the PC control system and projector maintenance.

12G/SDI IN / OUT

Connect to 12G SDI source.



Note for Trigger

- When the projector is turned on, a control output signal (DC 12V) is delivered from this terminal.
- Do not use this jack for anything other than intended use.



Note for Wired Remote

Please make sure whether the port for insertion is correct before the terminal of the wired remote control is inserted. The remote control may be damaged if inserted to the wrong port such as trigger. Do not use this jack for anything other than intended use.

Control Panel

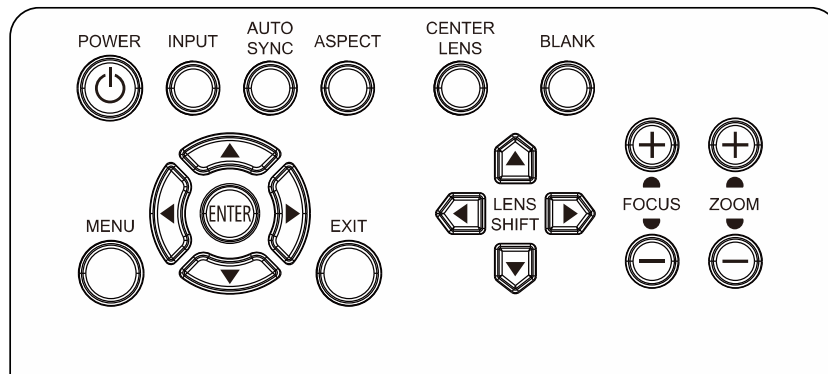

POWER

User the button to turn on/off the projector.

INPUT

Push the button to select the input signal. HDMI, DVI,...etc.

AUTO SYNC

Push the button to auto source.

ASPECT

Changes the aspect ratio.

CENTER LENS

Centers the lens.

PIC MUTE

Shows and hides the projected image. When OFF, the light source is completely switched off and the screen is black.

MENU

Push the button to display or return to the menu on the previous level or exit the OSD menu.

ENTER

Use the button to select settings or confirm the changed settings.

UP/Down/Left/Right

Use the button to select the OSD option.

EXIT

Push the button to hide the OSD menu.

LENS SHIFT

Use these four buttons to move the projected image to the desired position.

FOCUS

Use the button to adjust the focus of the projected image.

ZOOM

Use the button to zoom in/out the projected image.

Remote Control

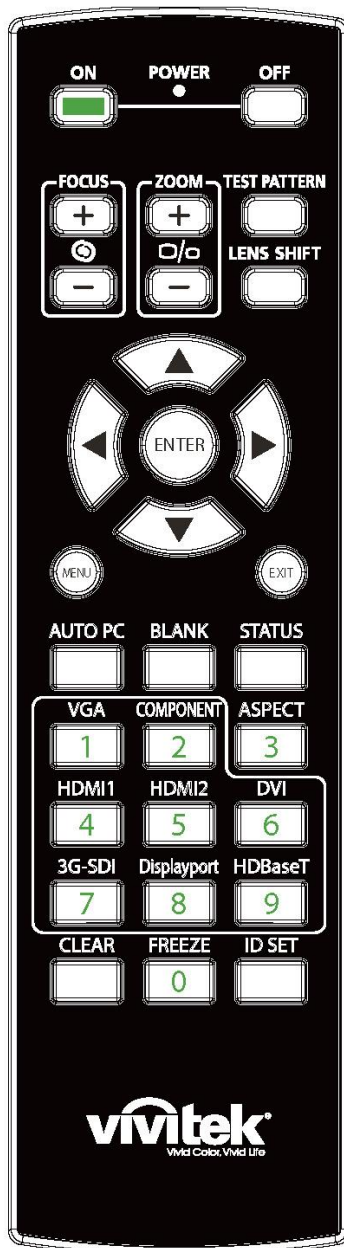

On

Use the button to turn on the projector.

OFF

Use the button to turn off the projector.

FOCUS

Adjust the focus of the projected image.

ZOOM

Zoom in/out the projected image.

TEST PATTERN

Use the button to show the test pattern. Press this button again to switch to the next pattern. Press the EXIT button to return to the projected image.

LENS SHIFT

Use the button to move the lens top, down, right or left.

ENTER

Use the button to select settings or confirm the changed settings.

MENU

Push the button to display or return to the menu on the previous level or exit the OSD menu.

EXIT

Push the button to hide the OSD menu.

AUTO PC

You can use this function to execute signal source auto synchronization

BLANK

Press the button to temporarily interrupt the projection.

STATUS

Show OSD MENU – SERVICE.

VGA

NA.

COMPONENT

NA.

ASPECT

Press the button to display aspect ratio options.

HDMI1

Select HDMI 1 as the input source.

HDMI2

Select HDMI 2 as the input source.

DVI



Wired Remote Jack

Connect to WIRED REMOTE terminal on the projector.

Select DVI-D as the input source.

3G-SDI

Select 3G SDI as the input source.

DisplayPort

Select DisplayPort 1 as the input source.

HDBaseT

Select HDBaseT the input source.

CLEAR

Erase the set ID number of the remote control; refer to the section "Using Control ID for Multi-projector Application".

FREEZE

Freeze the projected image or resume the projection.

ID SET

Set up ID number for remote control; refer to the section "Using Control ID for Multi-projector Application".

Remote Control Operating Range

The remote control uses the infrared transmission to control the projector. It is not necessary to point the remote directly at the projector. Provided you are not holding the remote perpendicular to the sides or the rear of the projector, the remote will function well within a radius of about 10 meters (25 feet) and 15 degrees above or below the projector level. If the projector does not respond to the remote control, move a little closer.

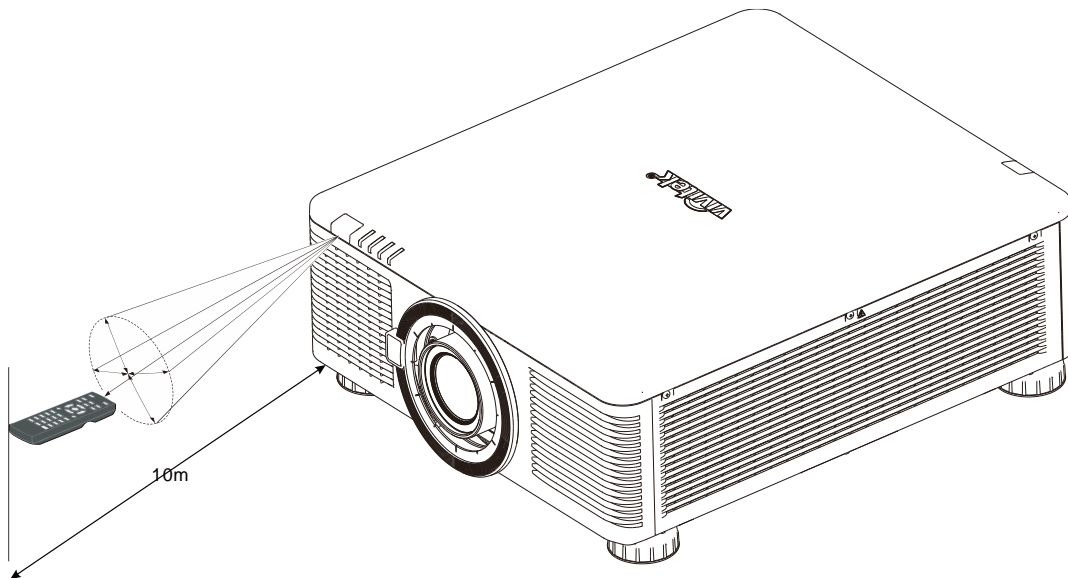

Installation and Setting up

Inserting or Changing the Remote Control Batteries

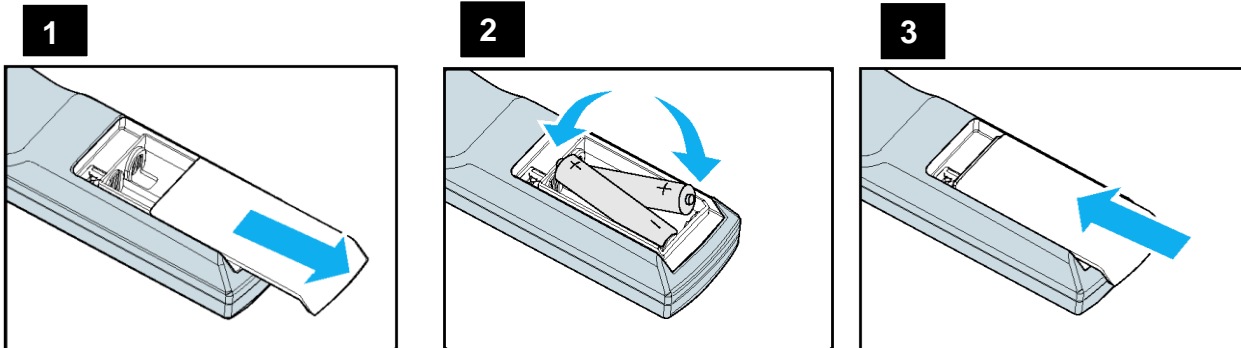

1. Remove the battery compartment cover by sliding the cover in the direction of the arrow.
2. Place two AA batteries with the correct polarity.
3. Replace and slide the cover as like the arrow in the illustration.



Important:

- Avoid using the projector with bright fluorescent lighting turned on. Certain high-frequency fluorescent lights can disrupt remote control operation.
- Be sure nothing obstructs the path between the remote control and the projector.
- Do not expose the remote control to high temperature or humidity; otherwise, the remote control will not function correctly.



Battery installation instructions

- Make sure the battery is installed with the correct polarity.
- Do not use the old and new batteries or the batteries of different types together.
- Remove the battery if the remote control is not being used for long periods of time to prevent damage caused by battery leakage.

Installing the Projector

The high quality display effect can be guaranteed only when the projector is correctly installed. Generally, the light source facing the screen should be reduced or eliminated as much as possible. The contrast of the image will be obviously reduced if the light directly shines on the screen, such as the beam from windows or the searchlight cast on the image. The image may become faded and not bright.

Precautions for Installation



Caution:

- Projector installation must be done by a qualified professional. Contact your dealer for more information. It is not recommended you install the projector yourself.
- With ceiling installation, use approved mounting hardware & M4 screws; maximum depth of screw is 16 mm. Contact your dealer for information about mounting the projector on a ceiling.
- Only use the projector on a solid and level surface. Serious injury and damage can occur if the projector is dropped.



Caution:

- Ensure that the hot air from the exhaust vent is not sucked into the projector.
- Ensure the air intake and exhaust vents are unobstructed and keep the required distance from any object. Below is required minimum distance between the vent and any object.
- All added enclosures should pass a certified thermal evaluation to ensure that the projector does not recycle exhaust air, as this may cause the projector to shut down even if the enclosure temperature is within the acceptable operation temperature range.

Airflow and Heat Emission

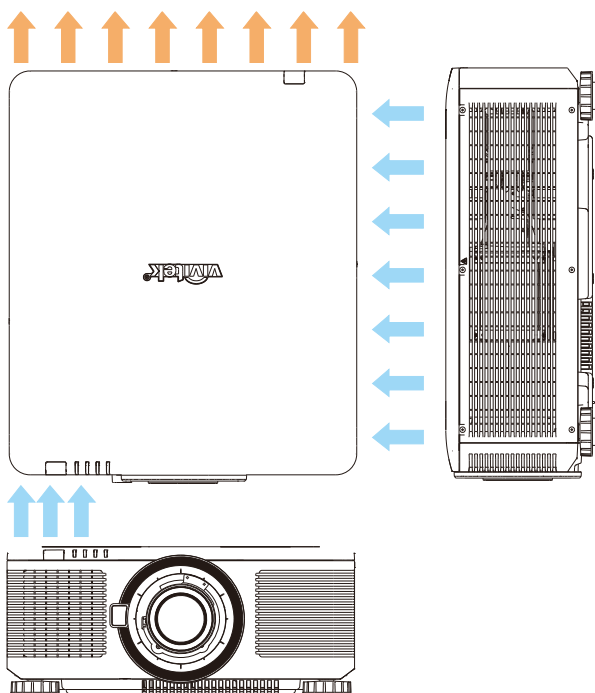

Minimum Distance to Vent

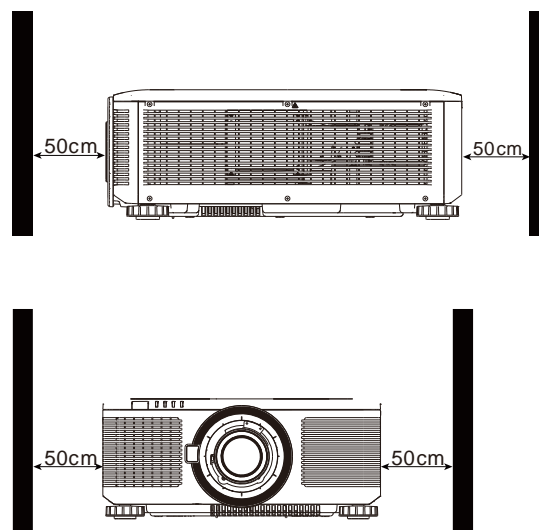

Caution:

- Only use the projector on a solid and level surface. Serious injury and damage can occur if the projector is dropped.
- Please do not stack the projector on the surface of another projector. Serious injury and damage may occur if the projector is dropped.

Mounting the Projector

For mounting the projector, please use UL Listed ceiling mounts and M4 screws, maximum depth of screw is 16 mm.

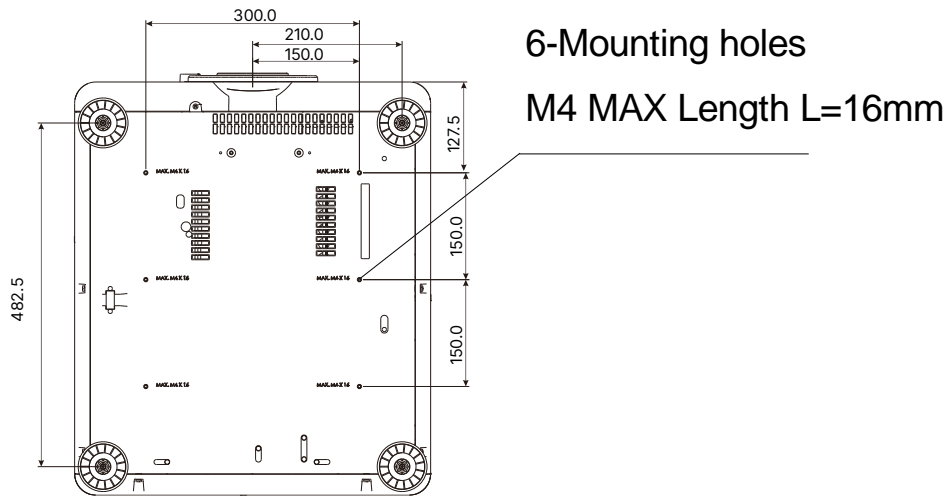

Installing or Removing the Optional Lens



Caution:

- Do not shake or place excessive pressure on the projector or the lens components as the projector and lens components contain precision parts.
- When shipping the projector with the optional lens, remove the optional lens before shipping the projector. The lens and the lens shift mechanism may encounter damage caused by improper handling during transportation.
- Before removing or installing the lens, be sure to turn off the projector and wait until the cooling fans stop, and turn off the main power switch.
- Do not touch the lens surface when removing or installing the lens.
- Keep fingerprints, dust or oil off the lens surface. Do not scratch the lens surface.
- Work on a level surface with a soft cloth under the projector to avoid scratches or other damage.
- If you remove and store the lens, attach the lens cap to the projector to keep out dust and dirt.

Install New Lens

1. IF the dust sponge is installed, Please remove the dust sponge.

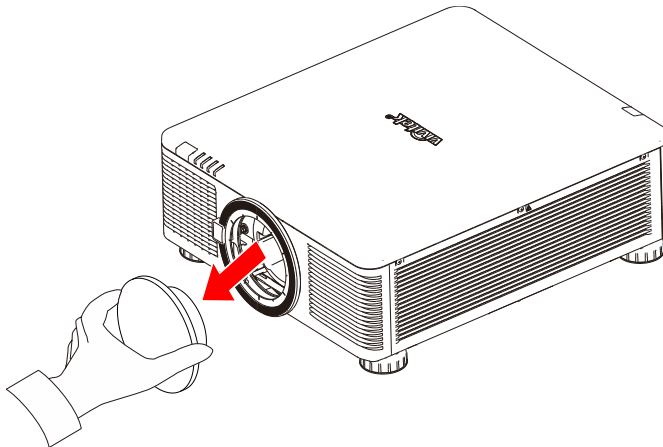

2. Align the flange and correctly position at the 11 o'clock position as shown in the picture, and gently insert it all the way into the lens mount and turn it clockwise to the "Lock" position. When turning the lens, the "Click" sound indicates that the lens is completely fixed and locked in place.

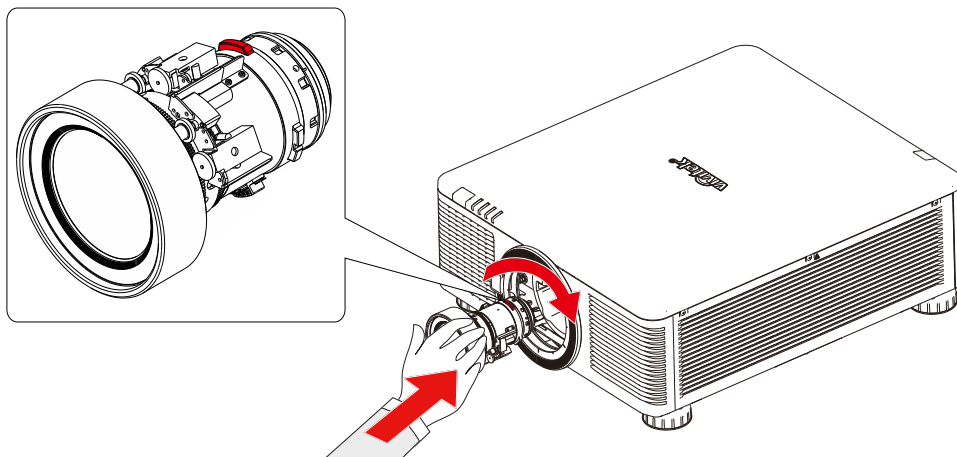

3. Check if the lens is fixed successfully by pulling the lens out of the holder gently.

4. For 0.31 ~ 0.33:1, 0.55 ~ 0.75:1, 0.74 ~ 1.08:1, 1.05 ~ 1.41:1, 1.4 ~ 2.11:1, 2.1 ~ 4.0:1 lenses, After installing the lens, You will need to use a 2.5mm hexagonal driver to secure the screws.

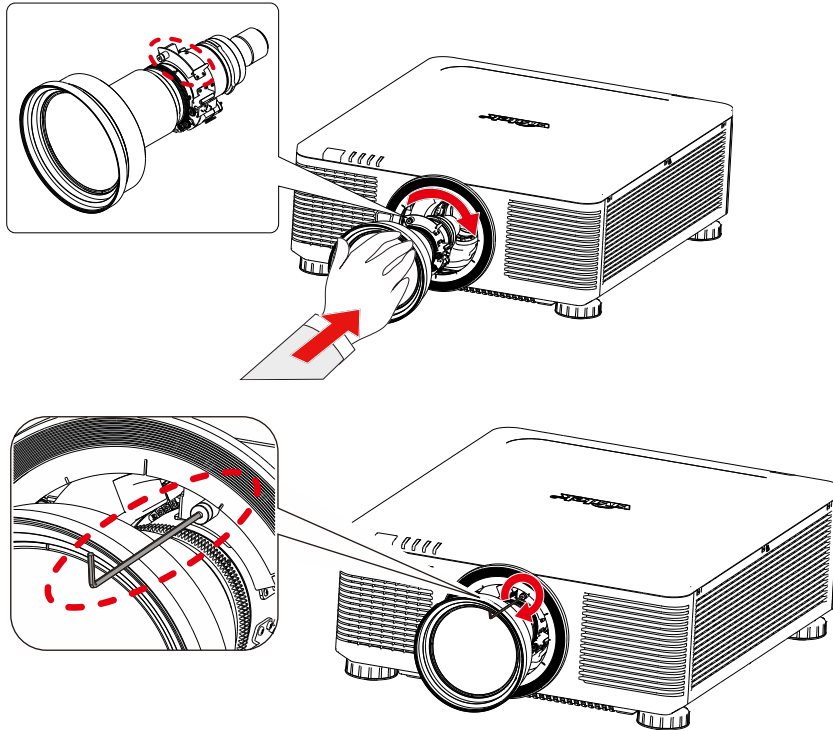

Removing the Existing Lens

1. Before disassembling the lens, please loosen the fixing screw first.
2. Push the LENS RELEASE button all the way in and rotate the lens counterclockwise. The existing lens will be disengaged.
3. Pull out the existing lens slowly.

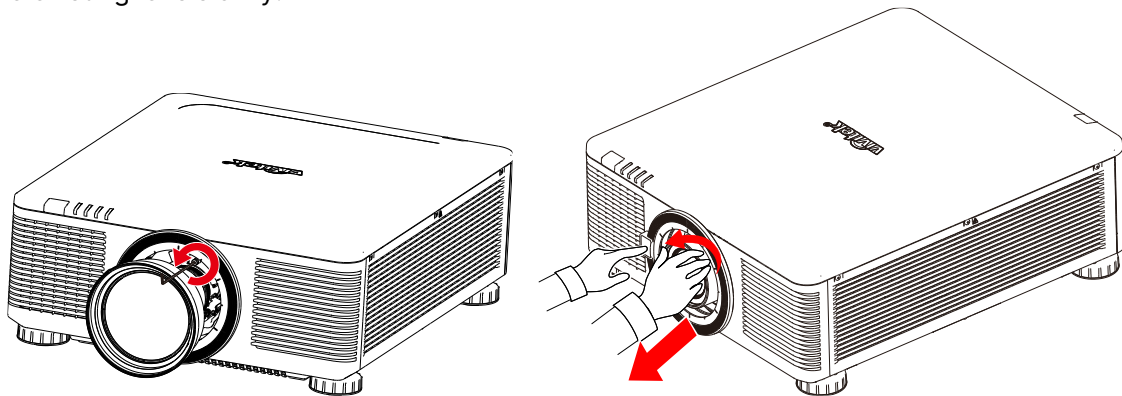

Important:

- When installing the lens into the projector, be sure to remove the lens cap from the back of the optional lens before installing the optional lens into the projector. Failure to do so will cause damage to the projector and lens.
- There is one safety switch inside the projector's lens slot to prevent unexpected injury by laser beam. The projector cannot be turned on if the projection lens has not been installed or is not installed correctly. Please make sure the lens is installed properly before tuning on the projector.

Connecting to AC Power Supply

The AC power cord is included in the box; plug the power cord to the AC socket on the IO panel.

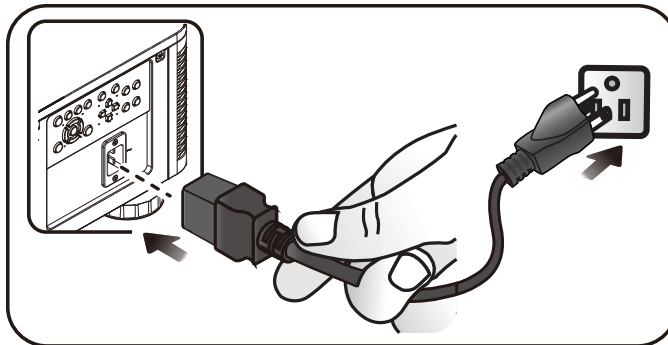

Turning On the Projector

Once the projector is correctly located and the power cable and other connections are in place, it is important that the projector is powered on correctly in order to avoid damage to components and un-necessary wear and tear. Refer to the following guide to power on the projector.

1. Press the POWER button on the control panel or ON button on the remote control.

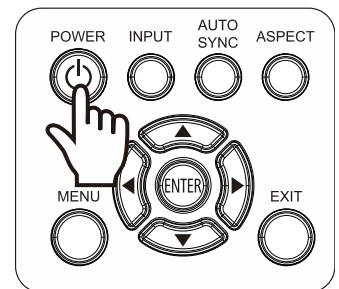
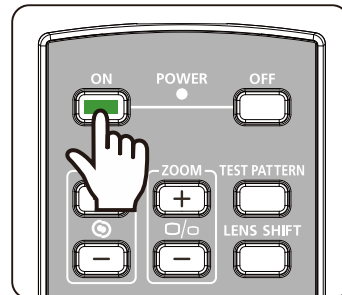

2. The Power LED flashes green until the power on process is finished.

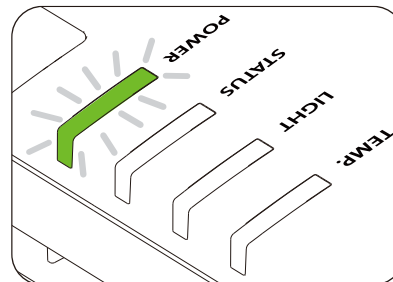

3. After a few seconds, LEDs lights will become a solid green to indicate the projector is ready for use.

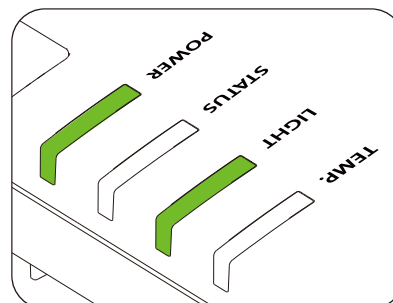

Turning Off the Projector

Once the projector is no longer required, it is important to shut it down correctly to avoid damage or unnecessary wear and tear on the device.



Important:

- Do not unplug the power cable from the wall outlet or projector when the projector is powered on. Doing so can cause damage to the projector's AC IN connector or the prongs of the power cable plug. To turn off the AC power supply when the projector is powered on, use a power strip equipped with a power on switch and surge protector.
- Do not turn off the AC power supply within 10 seconds after making adjustment or changing the setting. Doing so is possible to cause loss of adjustments and settings and return to default

Refer to the following guide to shut down the projector.

1. Press the POWER button on the control panel or OFF button on the remote control once, the Power Off window displays.
2. Press the POWER button again on the OSD control panel or remote control to verify power off.

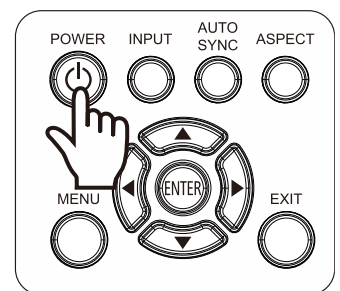
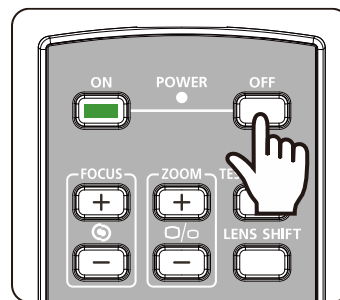

Power Off?
Press Power again

Adjusting the Projection Mode

Projector is designed for set up in all angles including desktop, ceiling, portrait and free-tilt installation as shown in the below illustration.

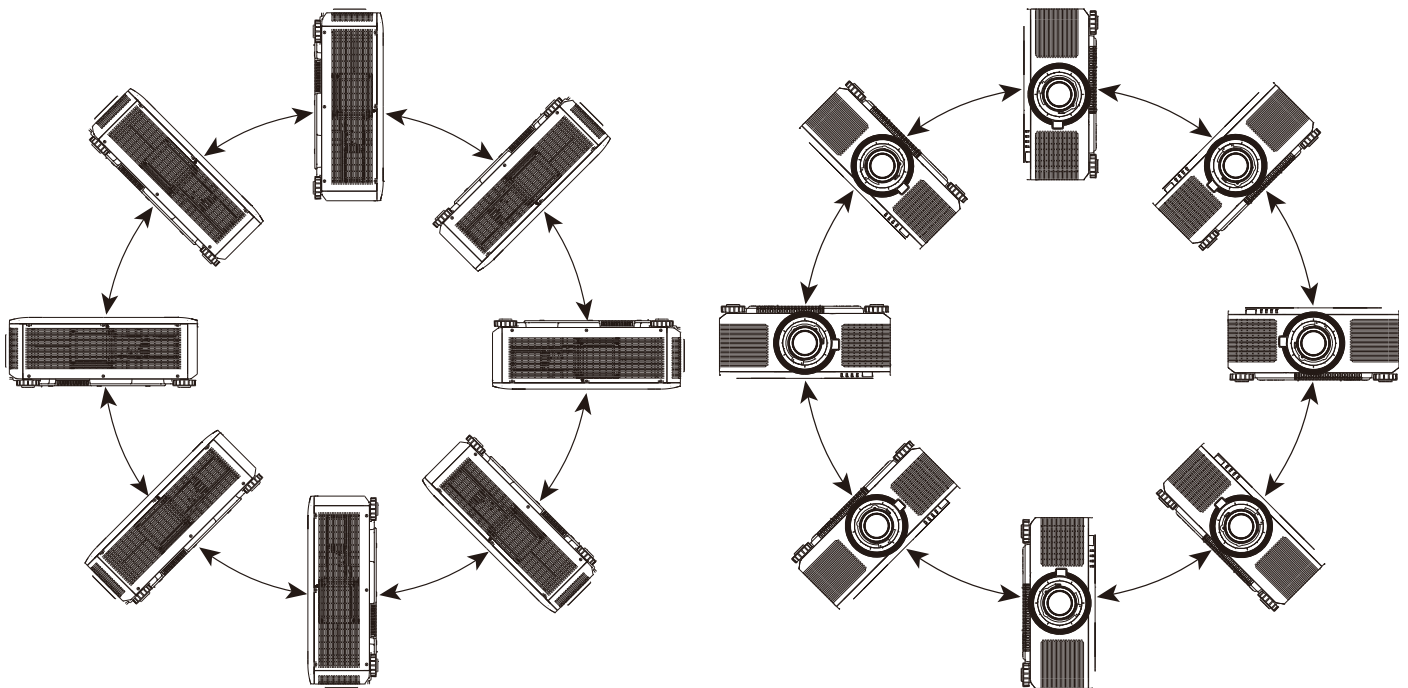

You can change the direction of the image using the Projection Mode. The projector has a smart cooling mechanism, which regulates the fan automatically according to the projection mode.

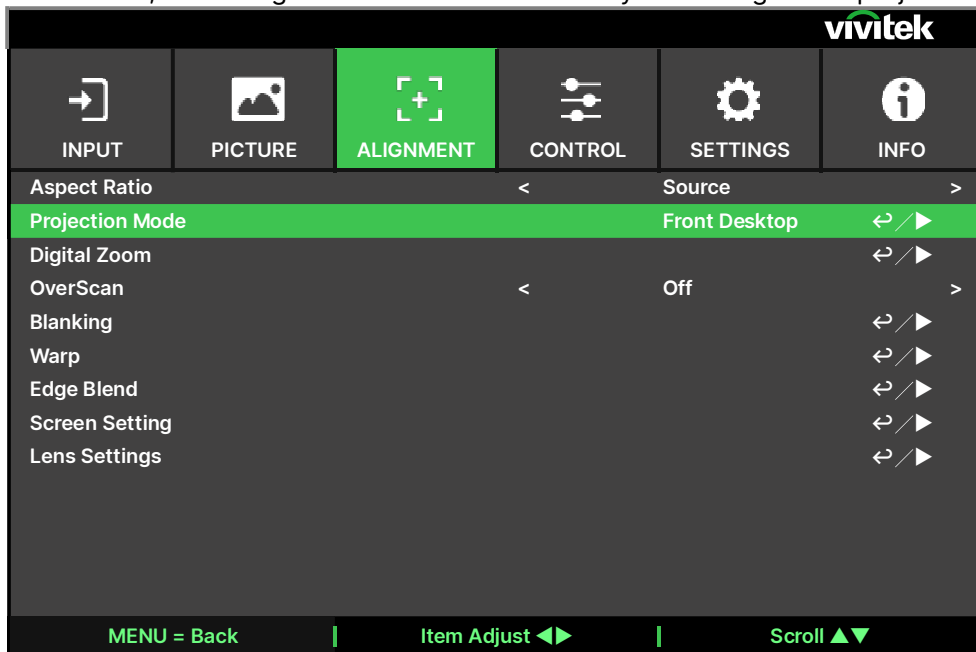

Press ENTER or ► button enter the sub menu and use the ▲▼ button to select a projection mode to flip the projected image as installation orientation or viewing direction. The selection options are described as below.

- Front Desktop:** Install the projector on the desktop and project the image forward.
- Rear Desktop:** Install the projector on the desktop and project the image from the rear of the screen.
- Front Ceiling:** Mount the projector on the ceiling and project the image forward.
- Rear Ceiling:** Mount the projector on the ceiling and project the image from the rear of the screen.

Adjusting the Projected Image Position

The projector has the powered lens shift feature; the image can be shifted vertically or horizontally without moving the projector. The lens shift range is shown in the percentage of the image height and width, the maximum vertical shift range can be up to 60% of the projected image height and down to 60% of the height, and maximum horizontal shift range is 20% of the image width to right and left. Please refer to below illustration.

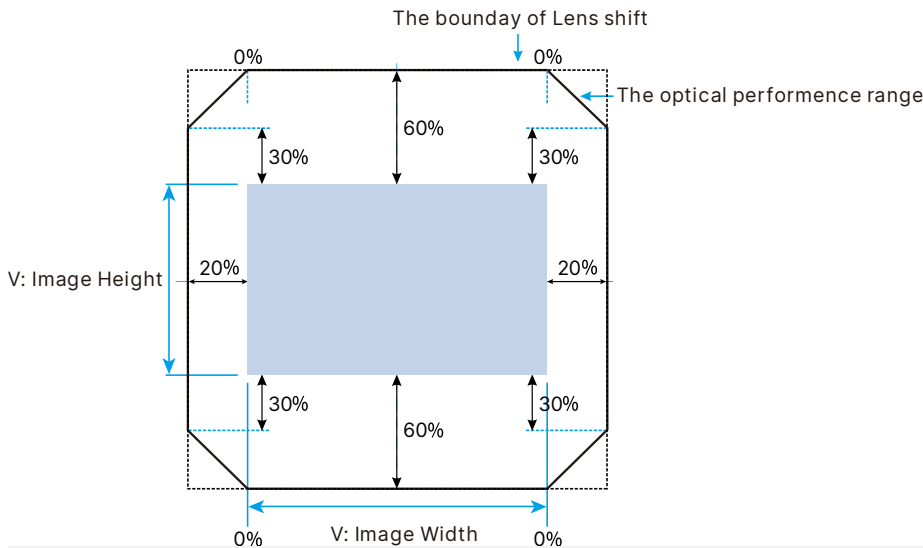

Note:

- The projector is equipped with a safety switch inside the lens mount hole. The projection lens must be installed in the projector before turning on the power or the projection can't be displayed.
- There is a Lens Lock function on OSD menu to disable lens control adjustment for avoiding possible misoperation after you finish the adjustment. Please make sure to disable the lock before performing the lens control.

Adjusting the Focus and Zoom

The focus and zoom can be adjusted from the projector control panel or remote control. Refer to the following guides to adjust the focus and zoom manually.

Press the Focus or Zoom button on the control key panel or remote control to adjust the focus or zoom effect using the increase and decrease buttons as required

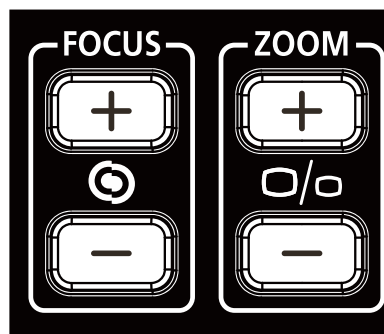
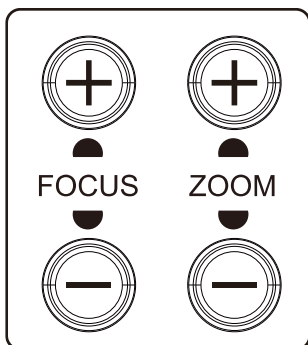

Adjusting Geometric Distortion

When the image is projected on a curved surface or screen at an angle, the image may become distorted. You can utilize the latest Vivitek Geometric Correction engine to make an image look visually correct when it is projected onto a non-planar screen or at an angle. The option as below figure, the available function combination is listed on the submenu of each geometry correction option.

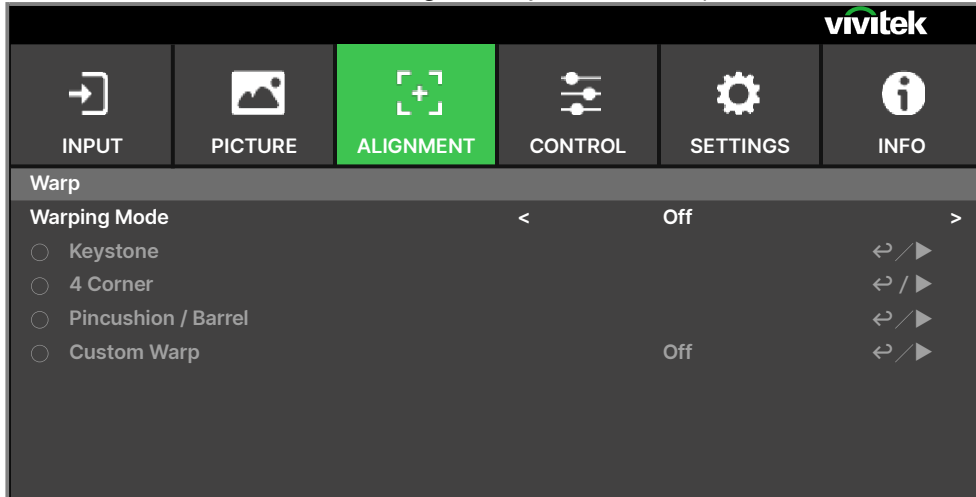

Keystone

Select the Keystone adjustment then use the ◀ or ▶ button to correct the distortion, the adjustable value in horizontal and vertical correction is ± 30 . The illustration is as below.

Horizontal Keystone:

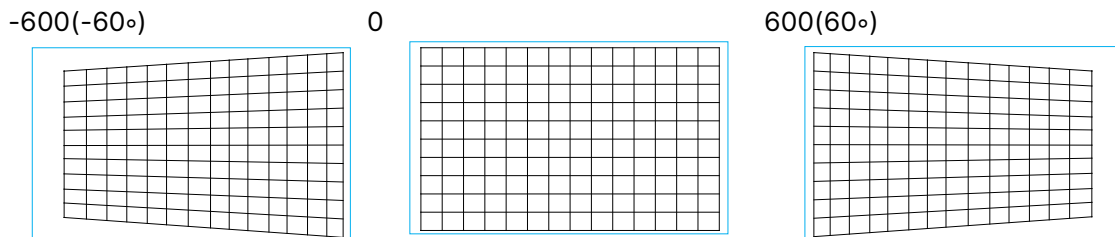

Vertical Keystone:

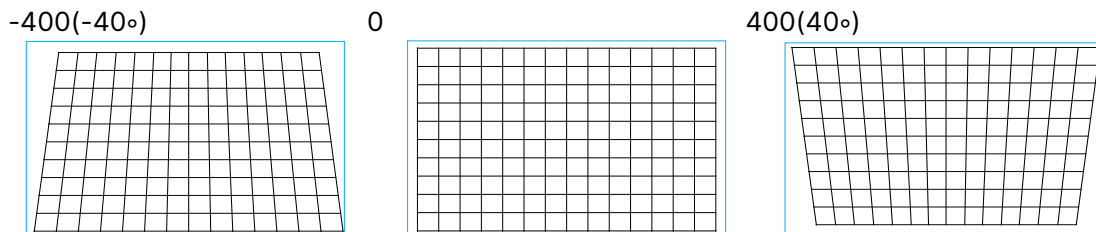

Besides correcting H and V Keystone by separate, you can use H and V keystone combination to correct the distortion. In this case, the effective range may be limited.

Rotation:

After H or V Keystone is adjusted, Rotation option is available for rotating the image if required. The option is only available if H or V Keystone is adjusted, Use the ◀ or ▶ button to rotate the image clockwise or counterclockwise.

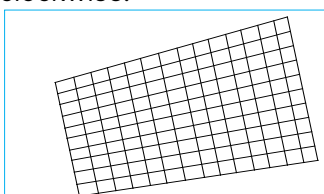

Rotate the projected image within active display area.

Use the ◀ or ▶ button to rotate the image clockwise or counterclockwise. Select Reset option to return Rotation setting to default value. Note that the image size is shrunk for projecting full image when Rotation is enabled; please refer to below illustration for adjustable range.

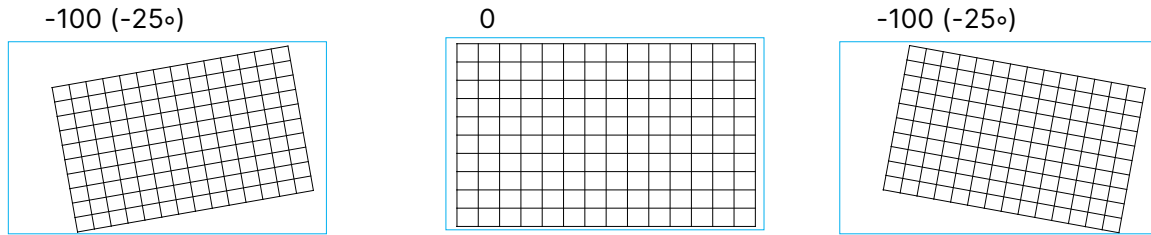

Lens Throw Ratio

Throw ratio is the ratio of the distance from the throw (the lens to the screen) to the projector screen's width. The larger the smaller the throw ratio, the closer you can place the projector to the screen or wall.

Reset:

Reset all of settings under this option to the default value.



Note:

Above adjustable range is for the case you adjust single dimension, the adjustable range of H and V Keystone combination is narrow if comparing with single- dimension adjustment.

4 Corner

In some applications, the distortion at the corner may occur due to the installation or projected surface. In this case, you can use Conner adjustment to correct the distortion corner by corner. Please refer to below illustrations

Top-Left Corner

Horizontal

-192 (Pixels)

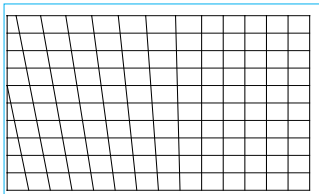

0

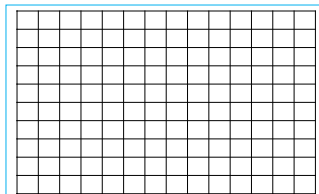

192 (Pixels)

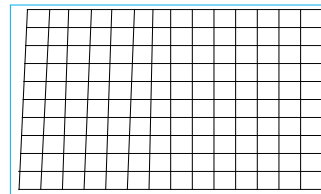

Vertical

-120 (Pixels)

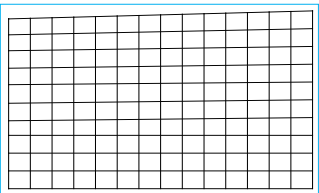

0

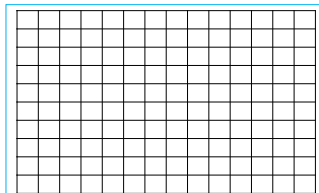

120 (Pixels)

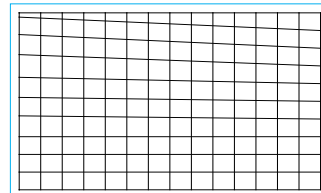

Top-Right Corner

Horizontal

-192 (Pixels)

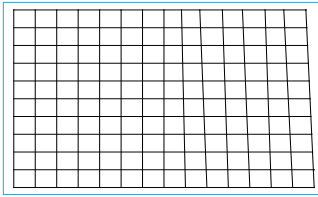

0

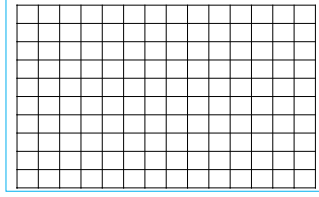

192 (Pixels)

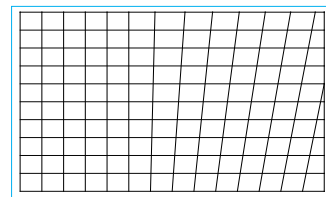

Vertical

-120 (Pixels)

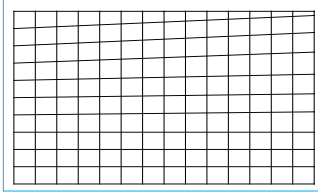

0

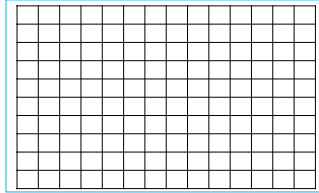

120 (Pixels)

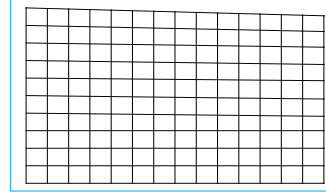

Bottom-Left Corner

Horizontal

-192 (Pixels)

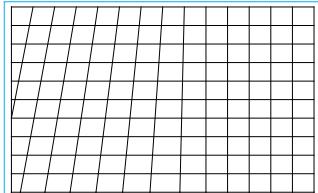

0

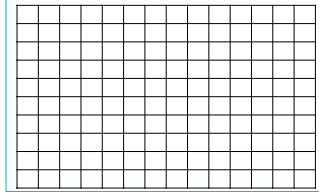

192 (Pixels)

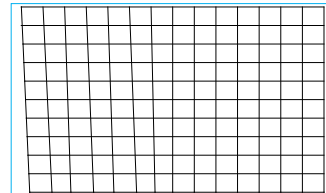

Vertical

-120 (Pixels)

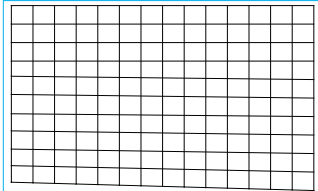

0

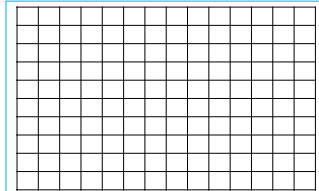

120 (Pixels)

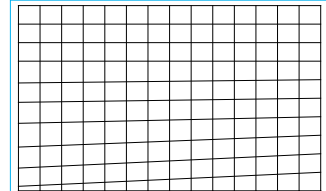

Bottom-Right Corner

Horizontal

-192 (Pixels)

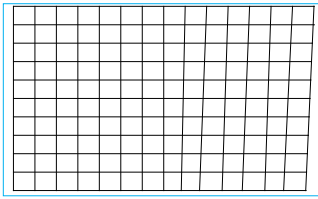

0

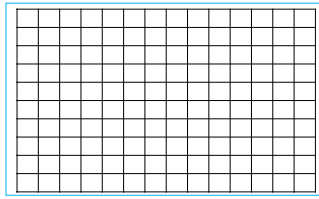

192 (Pixels)

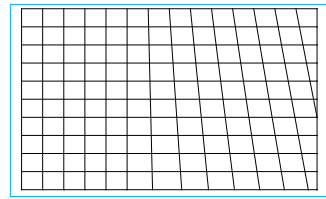

Vertical

-120 (Pixels)

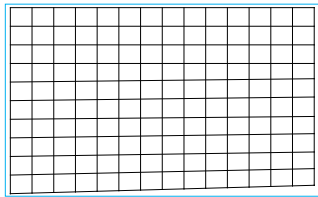

0

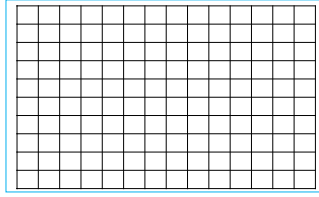

120 (Pixels)

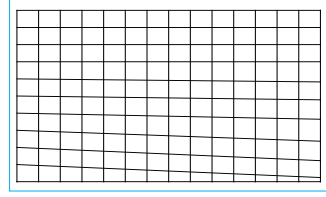

H Linearity

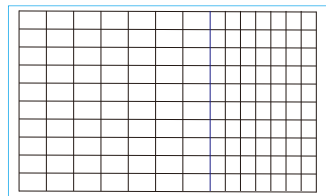
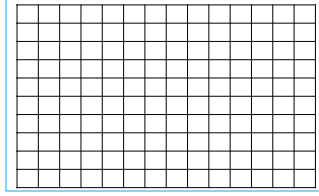
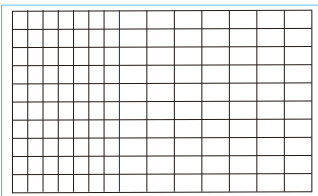

V Linearity

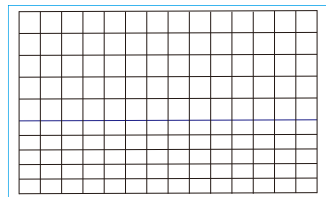
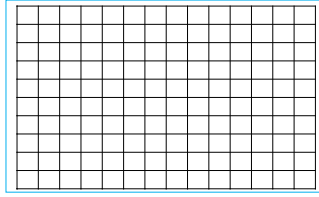
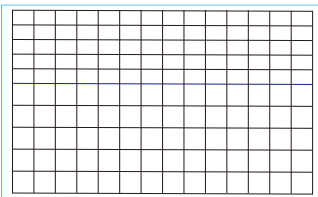

Reset

Reset all of settings under this option to the default value.

Pincushion / Barrel

When image is projected onto a cylindrical screen or hemispherical domes, you can use Pincushion / Barrel Correction to correct the distortion. Use the ◀ or ▶ button to adjust Pincushion / Barrel effect, Keystone or rotate the image by Rotation option.

Top

-150 (-30%)

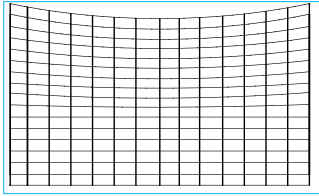

0

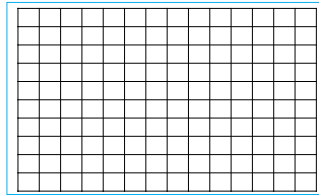

150 (30%)

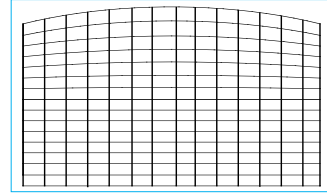

Bottom

-150 (-30%)

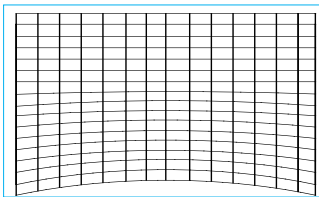

0

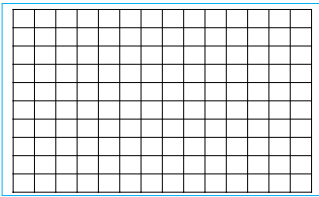

150 (30%)

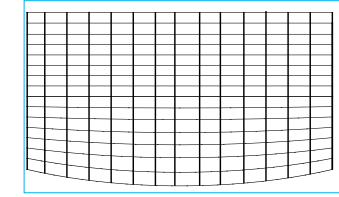

Right

-150 (-30%)

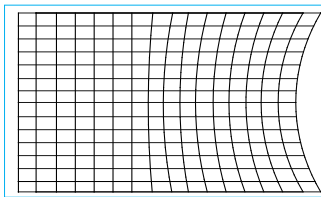

0

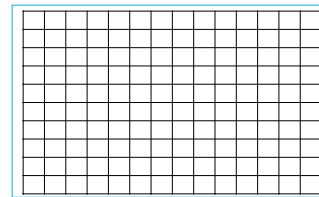

150 (30%)

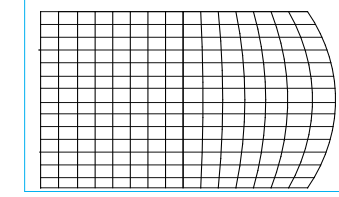

Left

-150 (-30%)

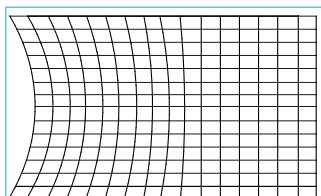

0

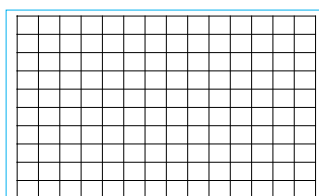

150 (30%)

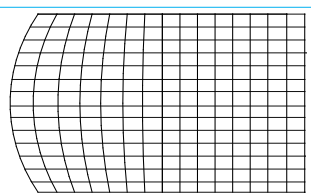

Keystone

Below is an example of using Horizontal Keystone

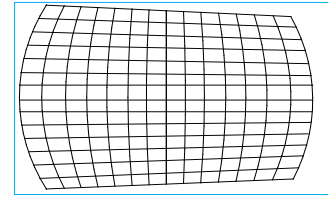
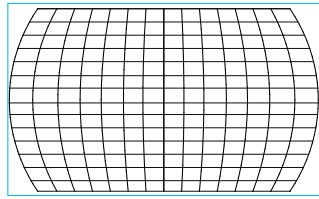
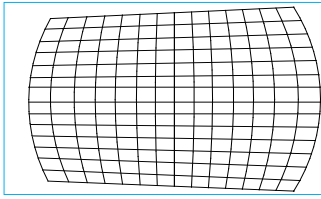

Note:

- H or V Keystone is available when Horizontal or Vertical of Pincushion/Barrel is adjusted.
- Rotation is available when H or V Keystone is adjusted.
- When rotation is adjusted, the image size is shrunk to fit for the active display area.

Lens Throw Ratio

Throw ratio is the ratio of the distance from the throw (the lens to the screen) to the projector screen's width. The larger the smaller the throw ratio, the closer you can place the projector to the screen or wall.

Reset

Reset all of settings under this option to the default value.

Custom Warp

Apply the geometry adjustment using a PC projector tool.

Using Control ID for Multi-Projector Application

When installing more than one projector in the room, the projectors may receive the control signal at the same time. In this case, you can use control ID function to specify the identification of the projector and remote control to operate the specified projector. Follow the below steps to set up the identification number for the projector and remote control.

Set the Projector identification number

1. Enable Projector ID Control function from CONTROL->Infrared Remote as below figure.

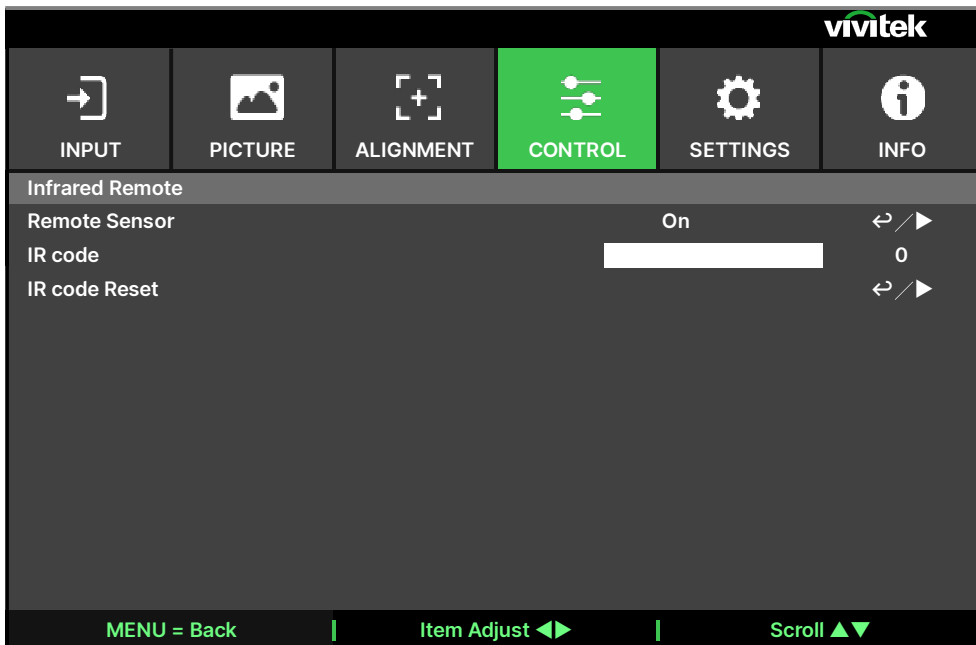
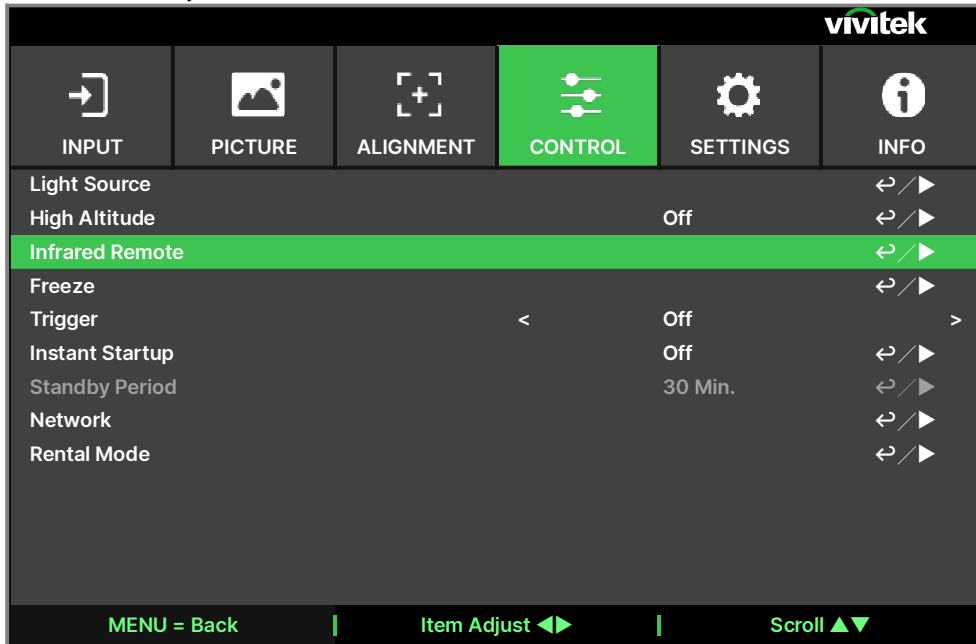

2. Set IR Code

Select IR Code option then press Enter button, use the ► button to increase the number or the ◀ button to decrease the number.

Set the identification number of remote control

Press and hold ID SET button on the remote control around 5 seconds, Power LED indicator is flashing red periodically. Press two digits to set desired ID number, each pressing shall be leisurely. Power LED will flash on time when the remote control is confirmed the setting.

Press and Hold ID SET button around 5 seconds



Power LED is flashing

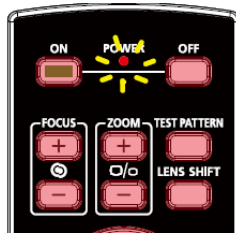

Press two digits for ID number



Note:

Setting the identification number will overwrite the ID number you had set. You can set the ID number directly if you would like to give a new ID number for the remote control.

Erase the identification number of the remote control

The set ID number is overwritten if new ID number is set, you can press ID SET and CLEAR button to erase ID number of the remote control.

Press ID SET and CLEAR buttons simultaneously



The backlight of the buttons is flashing one time



Note:

- Project ID Control function is available when the option is turned on and remote control wire is not plugged into the wire remote jack port.
- If ID Control Enable is set to Off, the projector can receive any control signal from the remote control. Even if the ID number is set into the remote control.

Using the Constant Brightness Function to Maintain the Brightness Output

The brightness output of a projector may decline after thousands of hours of usage. In certain applications, such as mapping, a periodical adjustment to multiple projectors is required to ensure the overall image result. Vivitek’s Constant Brightness feature is designed to reduce the need for installers to regularly recalibrate the projectors. A built-in light sensor inside the projector monitors the level of light so that when a reduction in light is detected, the projector will regulate dynamically the electricity power to increase the light output to your pre-defined brightness level, and thus maintaining a constant level of brightness. To use this function, follow the steps below:

1. Select CONTROL > Light Source > Custom Light. Change it to Custom Light Level with a value under 100%. For example: 90% or 85%. The reduced power percentage will be used to later regulate the brightness when the Constant Brightness function is enabled.

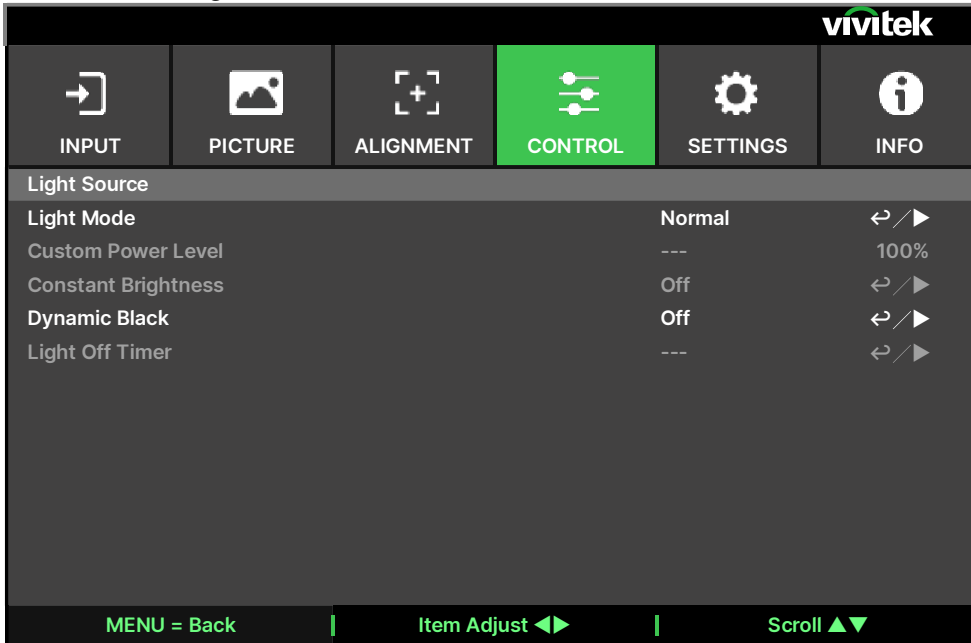

2. Enable the Constant Brightness function

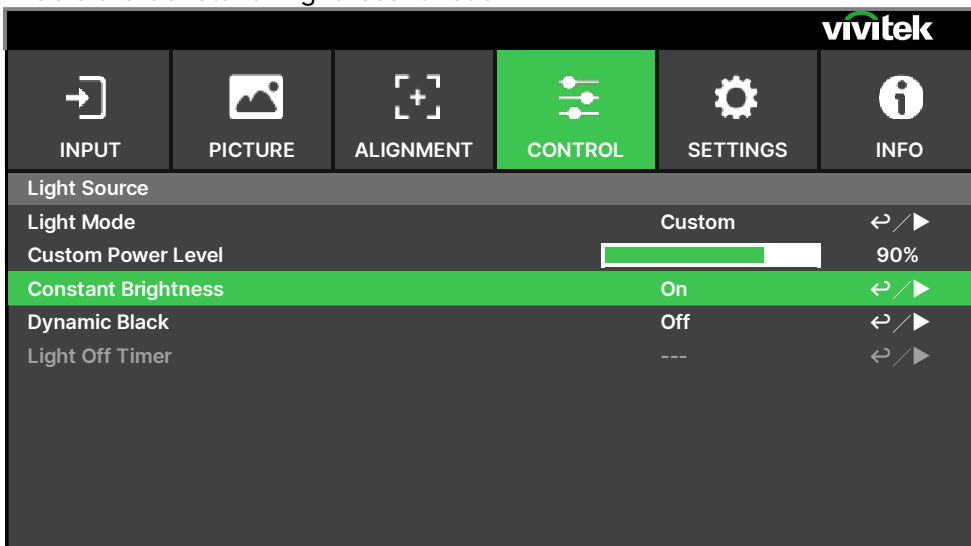

Note:

After a long period of time, when a power boost reaches its limit of maximum power, the Constant Brightness function will no longer increase the electrical power to the laser light source. In this case, please turn off the Constant Brightness function. You can also readjust all the projectors to a new level of brightness with a lower Customer Power Level percentage, so that the Constant Brightness function will work again.

Connecting Equipment

Follow the instructions below to connect the projector to a video source or external control equipment (if any). When connecting to the equipment, use the correct signal cable to connect to the signal source and ensure that the cable is securely connected. Fasten the nut on the joint and connect the signal source equipment to the projector according to the image below.

Connecting a Computer

Connect the PC signal to be projected to the projector through the DVI-D, HDMI cable.

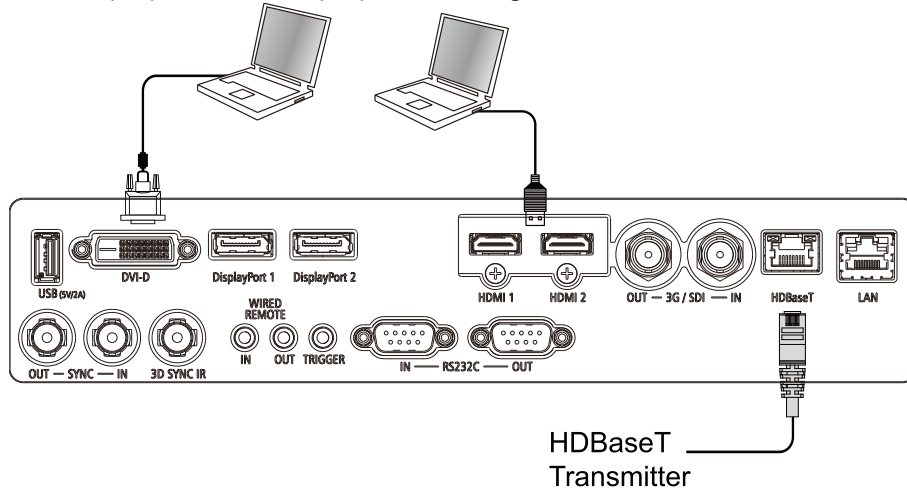

Connecting a Video Device

Connect video equipment to the input port of the projector via the DVI-D, HDMI Connector.

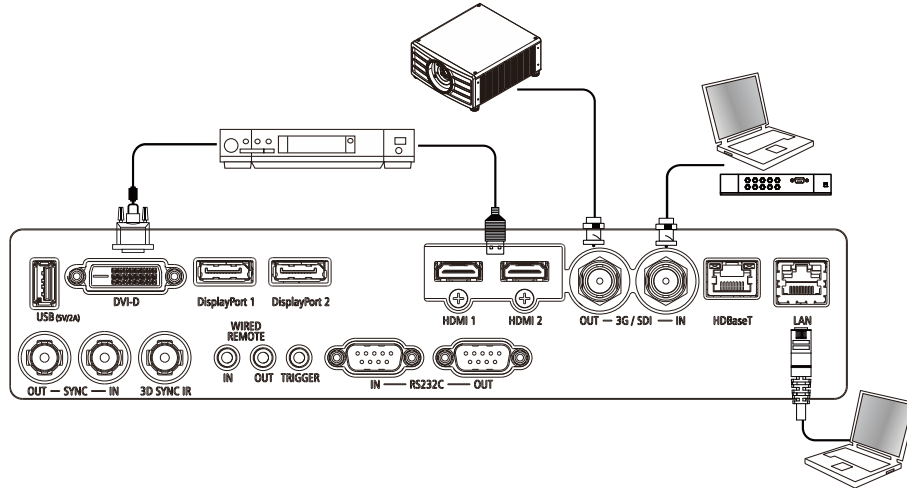

Connecting to a Control Equipment

The projector has the following control port for connecting to the control equipment:

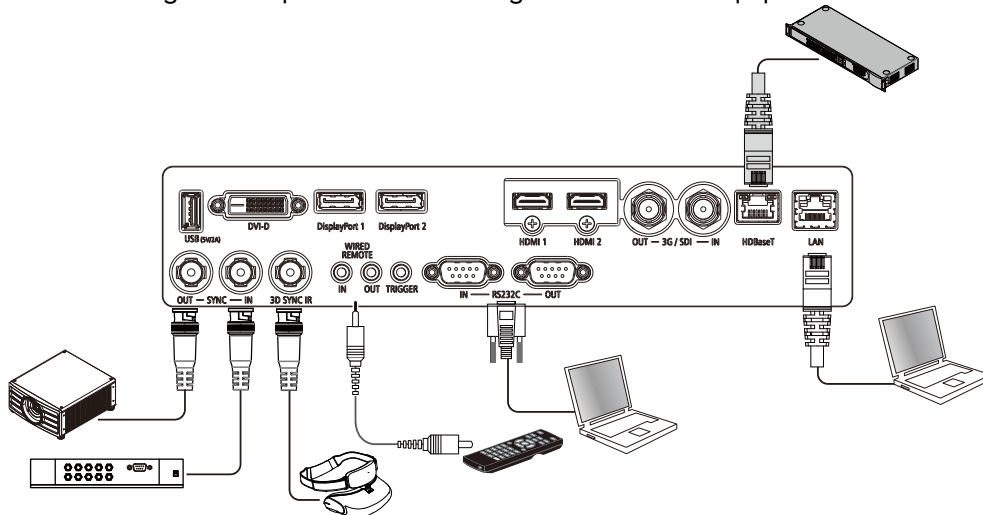

HDBaseT/LAN (Network control): The projector supports network control. LAN and HDBaseT share the same port. If only network control is used, you can connect the LAN on the projector to PC or through the local network. Refer to the Remote Communication Manual for detailed information.

RS-232 (RS-232 control): The projector can be remote-controlled by connecting the projector to a PC or control system through the standard 9-pin serial cable (Straight Through Serial Cable). Refer to the Remote Communication Manual for detailed information.

Wired remote control: If the projector cannot receive the IR signal from the remote control due to the overly long distance or obstacles, you can connect the cable to the IR remote control or the external IR transmitter (optional) via the WIRE input port to expand the working range of the remote control.

Sync Out/In: Connect to 3D IR sync signal transmitter or device.

3D SYNC IR: Connect 3D IR glasses receiver unit.



Note:

- When the terminal of the remote control cable is inserted to the wired control terminal of the projector, the projector will automatically switch to the wired control mode and cannot be controlled through the IR signal of the remote control. Disconnect the wired control terminal on the projector if you want to control through the IR signal of the remote control.
- If the wired remote control cable or the external IR transmitter is inserted to the incorrect port such as Trigger, the remote control or the IR transmitter may be damaged. Make sure whether the port is correct.

Connecting a Screen Trigger

If your projection system includes a electric projection screen and other 12V trigger device, you can connect these devices to the projector's 12V trigger output port to configure the 12V signal settings. The projector will output 12V signals when it's turned on. You can use the signal to control the screen or device by turning on the OSD option under CONTROL -> Trigger

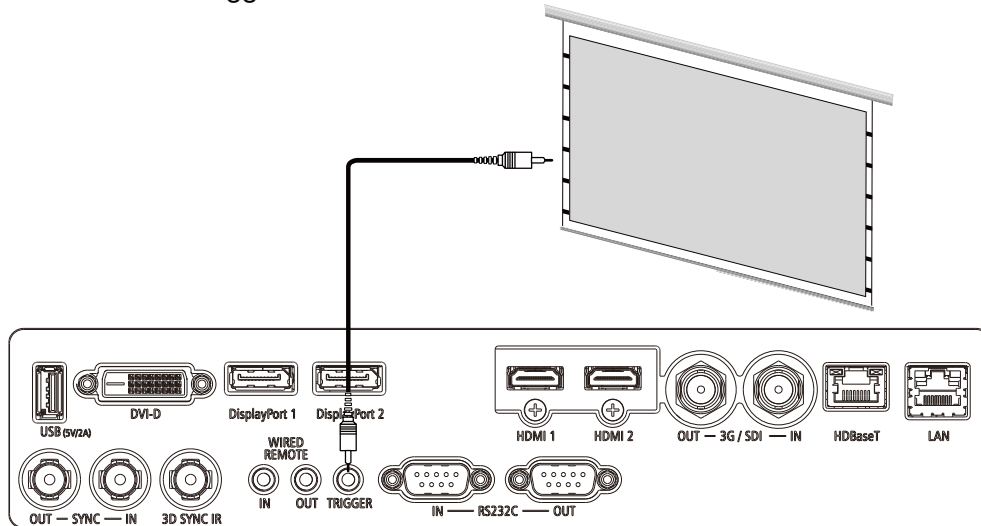

Connecting an HDBaseT Transmitter

The projector has a built-in HDBaseT receiver. With an HDBaseT Transmitter (optional), the video, RS-232 and LAN signals can be sent to the projector via a single RJ-45 cable. If the HDBaseT Transmitter you purchased supports the input and output of the IR remote control, the control signals from the IR remote control can be sent to the projector via the RJ-45 cable.

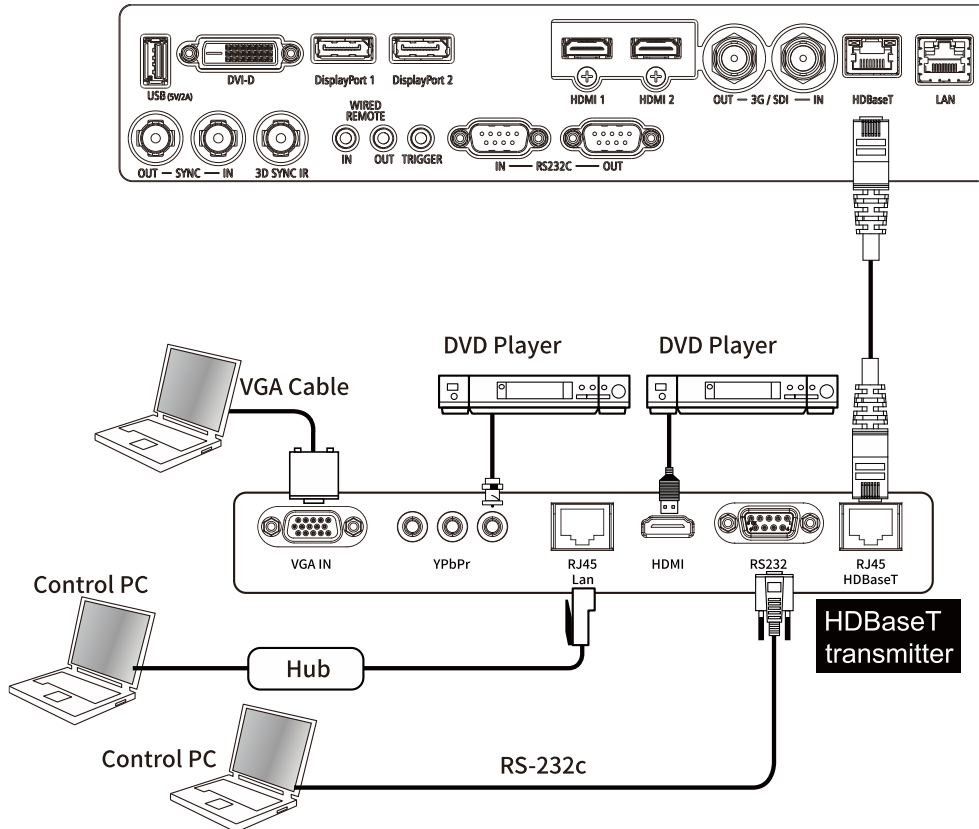

Note:

- The projector supports the video signal, R-232, IR remote control and the reception of the network control signals but do not support Power over Ethernet (PoE).
- The baud rate will be switched to 9600 automatically. If RS232 command is sent via external HDBaseT transmitter.
- If the command is sent via the HDBaseT transmitter, the longest transmission distance is 100 meters. If the transmission distance exceeds 100 meters, there is a possibility that the projection may be interrupted, or the control signal cannot be sent.
- Use the RJ-45 cable and avoid entwining. Entwining may cause damage or signal transmission interference, thus reducing the transmission distance and degrading the image quality.

Using the Projector

Using On-Screen Display

Using the On-Screen Display

The projector has an On-Screen Display (OSD) that lets you make image adjustments, change various settings and check the projector's current status.

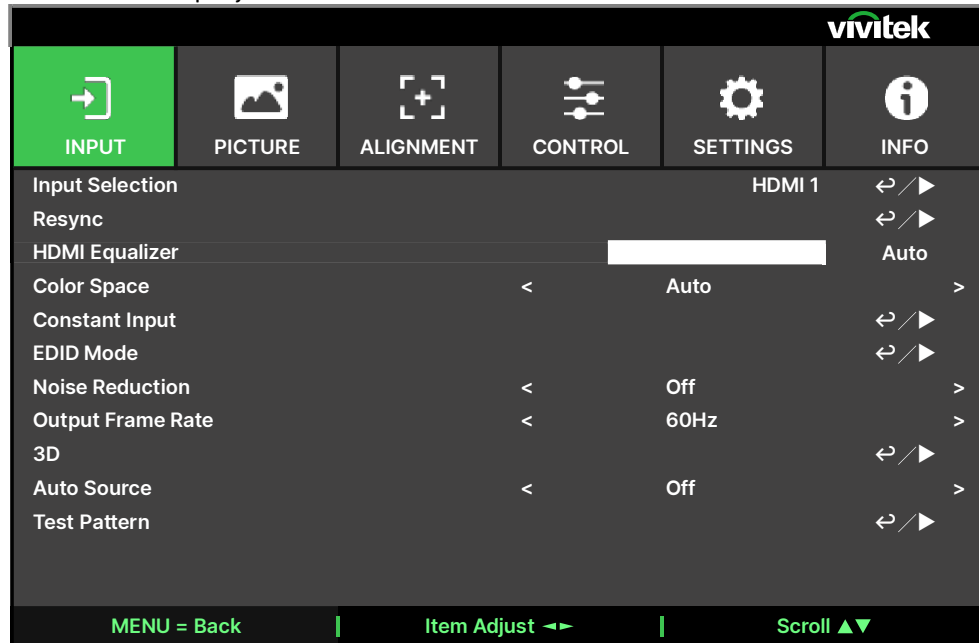

Navigating the OSD

You can use the remote control or the control buttons on the projector to navigate and make changes to the OSD. The following illustration shows the corresponding buttons on the remote control and on the projector.

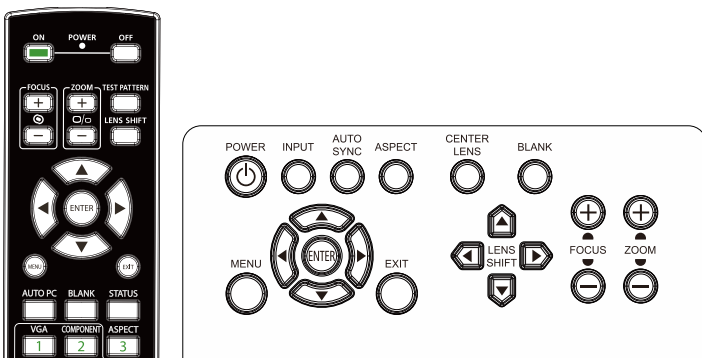

1. To open the OSD, press the Menu button on the OSD control panel or remote control. There are six folders on the menu. Press the ◀ or ▶ buttons to move through the submenus or secondary menus.
2. Press the ▲ or ▼ button to select the option and ▲▼◀▶ button to change values for settings. Press ↵ to confirm the new setting.
3. Press **MENU** to leave a submenu or **EXIT** to close menu.

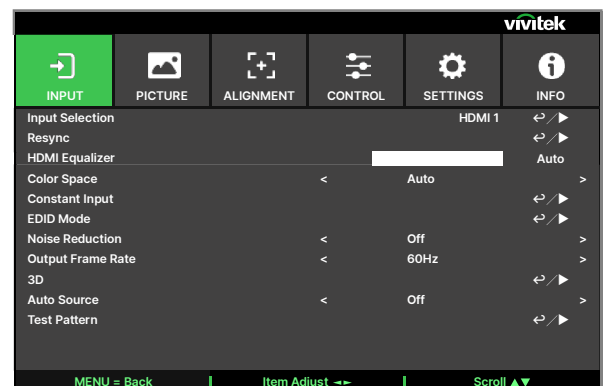

Menu Tree

Use the following table to quickly find a setting or determine the range for a setting.

| Main Menu | Sub Menu | Settings | |
|----------------|--|---|---|
| INPUT | Input Selection | HDMI 1 / HDMI 2 / DisplayPort1 / DisplayPort2 / HDBaseT / SDI / DVI | |
| | Resync | (execute) | |
| | HDMI Equalizer | Auto / 1 ~ 7 | |
| | Color Space | Auto / YPbPr / YCbCr / RGB PC / RGB Video | |
| | Constant Input | Auto Switching | Off / On |
| | EDID Mode | HDMI1 | 4K/60 HDR / 4K/30 / 1920x1200p60 / 1920x1080p60 / 1280x800p60 / 3840x1600p60 |
| | | HDMI2 | 4K/60 HDR / 4K/30 / 1920x1200p60 / 1920x1080p60 / 1280x800p60 / 3840x1600p60 |
| | | DisplayPort 1 | 4K/60 HDR / 4K/30 / 1920x1200p60 / 1920x1080p60 / 1280x800p60 / 3840x1600p60 |
| | | DisplayPort 2 | 4K/60 HDR / 4K/30 / 1920x1200p60 / 1920x1080p60 / 1280x800p60 / 3840x1600p60 |
| | | HDBaseT | 4K/60 HDR / 4K/30 / 1920x1200p60 / 1920x1080p60 / 1280x800p60 / 3840x1600p60 |
| | | Noise Reduction | Off / On |
| | Output Frame Rate | Auto / 48Hz / 50Hz / 60Hz | |
| | 3D | DLP Link | Off / On |
| | | 3D Format | Off / Auto / Side by Side (Half) / Top and Bottom / Dual Channel / Frame Sequential / Frame Packing |
| | | Eye Swap | Normal / Reverse |
| | | Dark Time | 0.65ms / 1.3ms / 1.95ms |
| | | Sync Delay | 0 ~ 100 ~ 200 |
| Sync Reference | | Internal / External | |
| Auto Source | Off / On | | |
| Test Pattern | Off / White / Black / Red / Green / Blue / Checkerboard / CrossHatch / ColorBar / Aspect Ratio (Pluge) | | |

| Main Menu | Sub Menu | Settings | | |
|-----------|-------------------|---|--|--|
| PICTURE | Picture Mode | High Bright / Presentation / Video | | |
| | Brightness | 0 ~ 100 ~ 200 | | |
| | Contrast | 0 ~ 100 ~ 200 | | |
| | Color Manager | Color | R / G / B / C / M / Y / W | |
| | | Hue (R / G / B / C / M / Y) | Red Gain (W) 0 ~ 500 ~ 1000 | |
| | | Saturation (R / G / B / C / M / Y) | Green Gain(W) 0 ~ 500 ~ 1000 | |
| | | Gain (R / G / B / C / M / Y) | Blue Gain(W) 0 ~ 500 ~ 1000 | |
| | | Reset | (OK) to execute | |
| | | Advanced | Saturation | 0 ~ 100 ~ 200 |
| | | | Hue | 0 ~ 100 ~ 200 |
| | | | Sharpness | 0 ~ 10 ~ 20 |
| | | | Gamma | 1.0 / 1.8 / 2.0 / 2.2 / 2.35 / 2.5 / DICOM |
| | | | Color Gamut | Native / REC709 / EBU/ SMPTE |
| | Color Temperature | 3200K/ 5400K / 6500K / 7500K / 9300K / Native | | |
| | Input Balance | R Gain | 0 ~ 100 ~ 200 | |
| | | G Gain | 0 ~ 100 ~ 200 | |
| | | B Gain | 0 ~ 100 ~ 200 | |
| | | R Offset | 0 ~ 100 ~ 200 | |
| | | G Offset | 0 ~ 100 ~ 200 | |
| | | B Offset | 0 ~ 100 ~ 200 | |
| | | Reset | (OK) to execute | |
| | | Uniformity | Uniformity Mode | Off/On |
| | Location H | | 0 ~ 8 (Slider bar) | |
| | Location V | | 0 ~ 5(Slider bar) | |
| | Red Gain | | -150 ~ 0 ~ 150 (Slider bar) | |
| | Green Gain | | -150 ~ 0 ~ 150 (Slider bar) | |
| | Blue Gain | | -150 ~ 0 ~ 150 (Slider bar) | |
| | Reset | | (OK) to execute | |
| | HDR | | Off / Auto / PQ-400 / PQ-500 / PQ-1000 / HLG | |

| Main Menu | Sub Menu | Settings |
|-----------|---------------------|---|
| ALIGNMENT | Aspect Ratio | 5:4 / 4:3 / 16:10 / 16:9 / 1.88 / 2.35 / LetterBox / Source / Native |
| | Projection Mode | Front Desktop / Front Ceiling / Rear Desktop / Rear Ceiling |
| | Digital Zoom | Digital Zoom -40 ~ 0 ~ 100 (0.6x ~ 1.0 ~ 2.0) |
| | | Digital Pan -1280 ~ 0 ~ 1280 (By Timing) |
| | | Digital Scan -720 ~ 0 ~ 720 (By Timing) |
| | | Reset (OK) to execute |
| | Overscan | Off / Crop / Zoom |
| | Blanking | Top 0 ~ 360 |
| | | Bottom 0 ~ 360 |
| | | Left 0 ~ 534 |
| | | Right 0 ~ 534 |
| | | Reset (OK) to execute |
| | Warp | Off / Keystone / 4 Corner / PinBarrel / Custom Warp |
| | Keystone | H keystone -360 ~ 0 ~ 360 |
| | | V keystone -360 ~ 0 ~ 360 |
| | | Rotation -250 ~ 0 ~ 250 (Slider bar, 0.1 degree / step) |
| | | Lens Throw Ratio Different adjustable range per lens type (number, 0.1 / step), refer to above 'Lens Type' function about the detail throw ratio definition. |
| | | Reset (OK) to execute |
| | 4 Corner | Top Left - H -192 ~ 0 ~ 192 |
| | | Top Left - V -120 ~ 0 ~ 120 |
| | | Top Right - H -192 ~ 0 ~ 192 |
| | | Top Right - V -120 ~ 0 ~ 120 |
| | | Bottom Left - H -192 ~ 0 ~ 192 |
| | | Bottom Left - V -120 ~ 0 ~ 120 |
| | | Bottom Right - H -192 ~ 0 ~ 192 |
| | | Bottom Right - V -120 ~ 0 ~ 120 |
| | | H Linearity 4K model: -350 ~ 0 ~ 350 WUXGA model: -170 ~ 0 ~ 170 |
| | | V Linearity 4K model: -200 ~ 0 ~ 200 WUXGA model: -100 ~ 0 ~ 100 |
| | | Reset (OK) to execute |
| | Pincushion / Barrel | Top -250 ~ 0 ~ 300 |
| | | Bottom -250 ~ 0 ~ 300 |
| | | Left -250 ~ 0 ~ 300 |
| | | Right -250 ~ 0 ~ 300 |
| | | H keystone -60 ~ 0 ~ 60 |
| | | V keystone -40 ~ 0 ~ 40 |
| | | Lens Throw Ratio Different adjustable range per lens type (number, 0.1 / step), refer to above 'Lens Type' function about the detail throw ratio definition. |
| | | Reset (OK) to execute |
| | Custom Warp | Off / User 1 / User 2 |

| Main Menu | Sub Menu | Settings | | |
|----------------|-----------------|--|---|---------|
| ALIGNMENT | Edge Blend | Edge Blend Mode | Off / On | |
| | | Align Pattern | Off / On | |
| | | Blend Start | Top | 0 ~ 360 |
| | | | Bottom | 0 ~ 360 |
| | Left | | 0 ~ 534 | |
| | Right | | 0 ~ 534 | |
| | White Level | Top | 4K model: 0, 100 ~ 1000 | |
| | | | WUXGA model: 0, 100 ~ 500 | |
| | | Bottom | 4K model: 0, 100 ~ 1000 | |
| | | | WUXGA model: 0, 100 ~ 500 | |
| | | Left | 4K model: 0, 100 ~ 1600 | |
| | | | WUXGA model: 0, 100 ~ 800 | |
| | | Right | 4K model: 0, 100 ~ 1600 | |
| | | | WUXGA model: 0, 100 ~ 800 | |
| | Black Level | Top Left - H | 0 ~ 960 | |
| | | Top Left - V | 0 ~ 600 | |
| | | Top Right - H | 0 ~ 960 | |
| | | Top Right - V | 0 ~ 600 | |
| | | Bottom Left - H | 0 ~ 960 | |
| | | Bottom Left - V | 0 ~ 600 | |
| | | Bottom Right - H | 0 ~ 960 | |
| | | Bottom Right - V | 0 ~ 600 | |
| | | Apply | (OK) to execute | |
| | | All | (Inc/Dec) | |
| | | Red | 0 ~ 255 | |
| Green | | 0 ~ 255 | | |
| Blue | | 0 ~ 255 | | |
| Screen Setting | Reset | (OK) to execute | | |
| | Screen Format | 16:10 / 16:9 / 4:3 / 2.35:1 | | |
| | Screen Position | Grey Out (When 16:10) / -60 ~ 0 ~ 60 (When 16:9) / -160 ~ 0 ~ 160 (When 4:3) / -191 ~ 0 ~ 191 (When 2.35:1) | | |
| Lens Settings | Lens Lock | Off / On | | |
| | Lens Type | 0.31 ~ 0.33 / 0.55 ~ 0.75 / 0.74 ~ 1.08 / 1.05 ~ 1.41 / 1.4 ~ 2.11 / 2.1 ~ 4.0 | | |
| | Lens Control | Popup menu for zoom, Focus and Shift control | | |
| | Lens Memory | Save Memory | Memory 1 / Memory 2 / Memory 3 / Memory 4 / Memory 5 / Memory 6 / Memory 7 / Memory 8 / Memory 9 / Memory 10 | |
| | | Load Memory | Memory 1 / Memory 2 / Memory 3 / Memory 4 / Memory 5 / Memory 6 / Memory 7 / Memory 8 / Memory 9 / Memory 10 | |
| | | Clear Memory | Memory 1 / Memory 2 / Memory 3 / Memory 4 / Memory 5 / Memory 6 / Memory 7 / Memory 8 / Memory 9 / Memory 10 | |
| Center Lens | (OK) to execute | | | |

| Main Menu | Sub Menu | | Settings | |
|-------------|--------------------------------|--------------------------|--|---|
| CONTROL | Light Source | Light Mode | ECO / Normal / Custom | |
| | | Custom Power Level | 30% ~ 100% | |
| | | Constant Brightness | Off / On | |
| | | Dynamic Black | Off / On | |
| | | Light Off Timer | Disable / 0.5 Seconds / 1.0 Seconds / 1.5 Seconds / 2.0 Seconds / 3.0 Seconds / 4.0 Seconds | |
| | High Altitude | | Off / On | |
| | Infrared Remote | Remote Sensor | Off / On | |
| | | IR code | 0~99 | |
| | | IR code Reset | (OK) to execute | |
| | Freeze Trigger | | (execute) | |
| | | | Off / Screen / 5:4 / 4:3 / 16:10 / 16:9 / 1.88 / 2.35 / LetterBox / Source / Native / RS232 | |
| | Instant Startup Standby Period | | Off / On | |
| | Network | Network Setup | DHCP | Off / On |
| | | | IP Address | xxx.xxx.xxx.xxx |
| | | | Subnet Mask | xxx.xxx.xxx.xxx |
| | | | Gateway | xxx.xxx.xxx.xxx |
| | | | DNS | xxx.xxx.xxx.xxx |
| | | | MAC Address | xx:xx:xx:xx:xx:xx (Information only) |
| | | | Apply | (OK) to execute |
| | | Art-Net Setup | Art-Net Enable | Off / On (2.X.X.X) / On (10.X.X.X) / On (Manual) |
| | | | Net | 0 ~ 127 |
| | | | Sub Net | 0 ~ 15 |
| | | | Universe | 0 ~ 15 |
| | | | Start Address | 1 ~ 508 |
| | | | Apply | (OK) to execute |
| | | Art-Net Channel Setting | Channel 1 | None / Power / PIC-MUTE / |
| | | | Channel 2 | Power Level / Input / |
| | | | Channel 3 | Channel Control |
| | | | Channel 4 | |
| | | | Channel 5 | |
| | | Art-Net Channel Status | Channel 1 | (channel setting and value) |
| | | | Channel 2 | (Information only) |
| | | Channel 3 | | |
| | | Channel 4 | | |
| | | Channel 5 | | |
| | AMX (Device Discovery) | | Off / On | |
| Rental Mode | Power Locked Level | Power Locked Level | 30% / 40% / 50% / 60% / 70% / 80% / 90% / 100% | |
| | | Power Locked Level Reset | (execute) | |
| | Usage Locked Time | Usage Locked Time | Disable / Enable | |
| | | Usage Time Setting (HRS) | 1 ~ 9999 | |
| | | Expiration Time Reset | (execute) | |
| | Change Password | New Password | 5 digits | |
| | | Confirm Password | 5 digits | |

| Main Menu | Sub Menu | Settings | |
|------------------|---------------------|---------------------|--|
| SETTINGS | Power Management | Standby Mode | ECO / On by Lan / On by HDBaseT |
| | | Auto Power Off | Off / 5 Min. / 10 Min. / 15 Min. / 20 Min. |
| | | Auto Power On | Off / On |
| | Image Latency | | Normal / Fast |
| | Blank Screen | | Logo / Black / Blue |
| | OSD Settings | Startup Logo | Off / Original / User |
| | | Menu Position | Top Left / Top Right / Bottom Left / Bottom Right / Center |
| | | Menu Transparency | 0 / 25 / 50 / 75 |
| | | Time Out | Always On / 10 Seconds / 30 Seconds / 60 Seconds |
| | | Message Box | Off / On |
| | | Menu Rotation | Off / Clockwise / Counterclockwise |
| | Memory | Recall Memory | Preset A / Preset B / Preset C / Preset D / Default |
| | | Save Settings | Preset A / Preset B / Preset C / Preset D |
| | Language | | English / Français / Español / Deutsch / Português / 简体中文 / 繁體中文 / 日本語 / 한국어 |
| | Factory Reset | | (OK) to execute |
| | INFO | Model | |
| | | Serial Number | |
| Software Version | | Control Module | |
| | | Video Module | |
| | | Option Module | |
| | | Formatter Module | |
| | | Light Module | |
| Laser Hours | | | |
| Signal Format | | Active Source | |
| | | Timing | |
| | | Scanning Frequency | |
| | | Pixel Clock | |
| | | Color Format | |
| | | HDR Format | |
| System Status | | AC Voltage | |
| | | Altitude Mode | |
| | | Laser Power | |
| | | Constant Brightness | |
| Thermal Status | | Inlet Temp. | |
| | | CW Temp. | |
| | | PW, TEC(DMD) Temp. | |
| | | BLD 1~4 Temp. | |
| | | BLD 5~8 Temp. | |
| | RLD, DMD(Ref) Temp. | | |
| | | | |
| | FAN Speed | | |

OSD Menu – INPUT

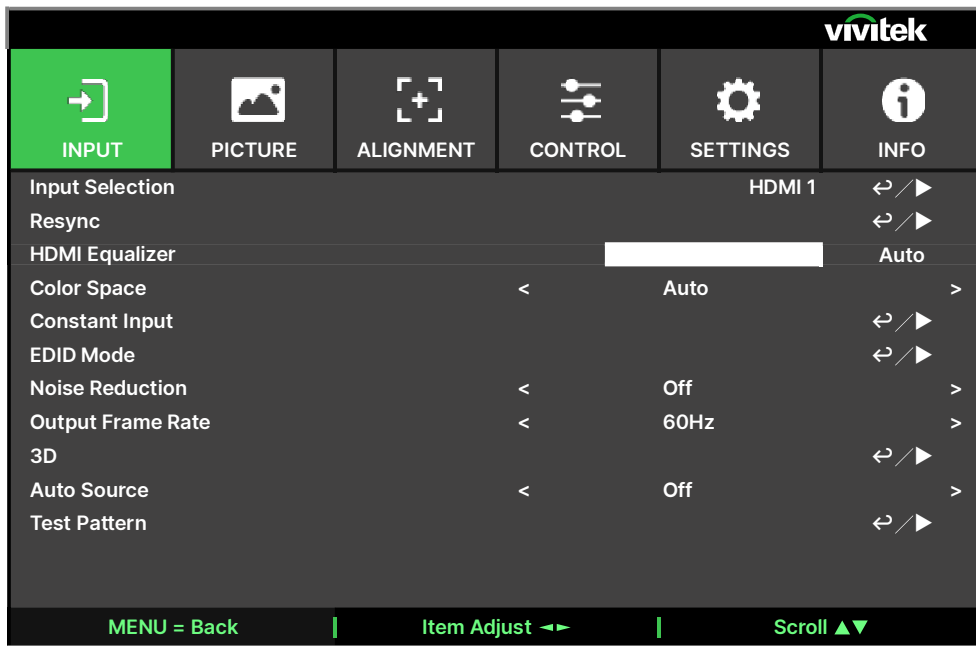

Input Selection

Use the shortcut key on the remote control or this function to select the input source. The Input options are as below.

The available input source of the product is HDMI 1, HDMI 2, DisplayPort1, DisplayPort2, HDBaseT, DVI and SDI.

Resync

To automatically synchronize the projector to the input source.

HDMI Equalizer

Sets a suitable value to maintain the HDMI picture quality in long distance data transmission.

Color Space

This function allows you to change the corresponding color space for the input signal in most cases, the default is Auto.

Auto: The projector detects the input signal and switches to the corresponding color space automatically.

YPbPr: Set the color space to ITU-R BT 601.

YCbCr: Set the color space to ITU-R BT 709.

RGB-PC: Use the RGB color space and set the black to 0, 0, 0 RGB, while set the white to 255, 255, 255 RGB (if an 8-bit image is used).

RGB-Video: Use the RGB color space and set the black to 16, 16, 16 RGB while set the white to 235, 235, 235 (if an 8-bit image is used) to correspond to the luminance value defined in the digital component standard.

Constant Input

Auto Switching: Enable auto-switch input source between HDMI1/2.

EDID Mode

Press ENTER, and use the ▲▼ buttons to select a EDID mode of HDMI1, HDMI2, DisplayPort1, DisplayPort2 and HDBaseT.



Note:

HDMI1/2 default EDID mode is 4K/60. But for some equipments , EDID mode is needed to select 4K/30 to catch the input signal normally.

Noise Reduction

Use ◀▶ to adjust the noise of the projected image. This function is used to remove the noise of the image with interlaced scanning input. Generally, noise reduction can lower the high-frequency details and make the image softer.

Output Frame Rate

Use ◀▶ to select the output frame frequency.

**Note:**

Will be grayed-out when 3D mode and force run in Auto option.

3D

This function is to set the 3D format and sync method. The projector detects the type of input signals and provides relevant options for settings. Before performing 3D setting, make sure that the input signal is connected.

DLP Link: This function is to activate or deactivate the DLP Link sync.

3D Format:

Off: Turn off the 3D Display Mode. When Auto, Side by Side, Top and Bottom, or Frame Sequential is selected, the 3D Mode will be turned on. To turn off the 3D Mode, select "Off" and press "ENTER".

Auto: Allow the 3D format to automatically detect the formats of Frame Packing, Top and Bottom, and Side by Side. The input signal is HDMI 1.4b 3D.

Side by Side (Half): This option is only applicable to input signal HDMI 1.4b 3D or HDMI signal sent by HDBaseT Transmitter.

Top and Bottom: This option is only applicable to input signal HDMI 1.4b 3D or HDMI signal sent by HDBaseT Transmitter.

Dual Channel: Display 3D by HDMI1 and HDMI2 with L / R.

Frame Sequential: Set input format under Frame Sequential.

Frame Packing: Set input format under Frame Packing.

Eye Swap: If the 3D image transmitted to the 3D glasses is reverse, you can set the Eye Swap to "Reverse" to normalize the image. Otherwise, keeping mode of "Normal" would be suggested.

Dark Time: Manually switch the Dark time for glasses tolerance, the available options are 0.65ms, 1.3ms and 1.95ms.

Sync Delay: If the 3D display shutter switch time of different brand 3D product is not synchronized with the projector, it will cause ghosting or poor 3D effect. Please adjust the sync delay to synchronize the 3D machine shutter and the projector shutter switching time for the best 3D projection.

Sync Reference: The projector provides DLP Link and 3D IR sync for 3D display, the projector will automatically set the sync signal depended on the 3D format and if the external 3D sync device is connected. This function is only applied to the condition that 3D Format is Frame Sequential or external 3D sync device is connected to the projector.

External: Signal is sent from external 3D sync signal receiver.

Internal: Signal is sent by the projector, 3D sync signal is DLP Link.

Important reminders:

- People with the following conditions should view 3D image with great care:
 - Children under six years in age
 - People who are sensitive to light or allergic to light, unhealthy and have a history of cardiovascular diseases.
 - People who are tired or lack of sleep
 - People who are under the impact of drugs or alcohol
 - Normally, it is safe to watch 3D images. However, some people might feel uncomfortable. Refer to the guidelines that were revised and released by the 3D League on December 10, 2008. It states that those who watch 3D images, need to take a break for at least 5 to 15 minutes every thirty minutes or one hour.

Auto Source

The Auto Source functions "ON" lets projector automatically search for the input signal.

Test Pattern

The built-in images are provided for installation and adjustment. You can select TEST PATTERN or Test Pattern on OSD or the TEST PATTERN button on the remote control to show the test pattern. Press the ◀▶ button to select pattern or press EXIT key again to exit the test pattern. The available test pattern options are Crosshatch, Color Bar, Checkerboard, White, Red, Green, Blue and Black.

OSD Menu – PICTURE

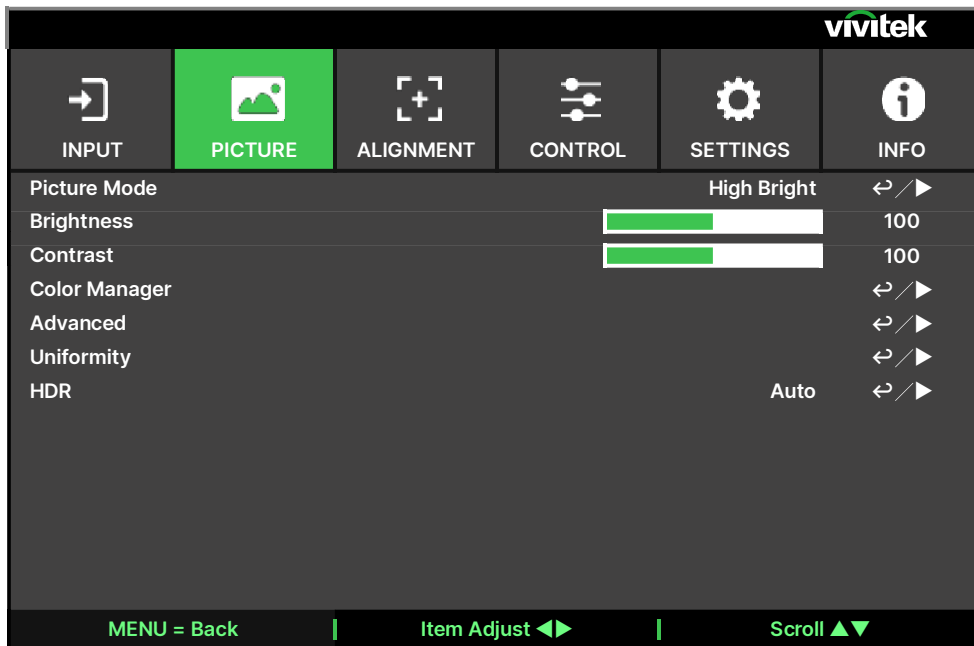

Picture Mode

You can use this function to select the picture mode:

High Bright: The highest brightness output mode is suitable for the application where the highest brightness output is needed.

Presentation: The best projection effect is suitable for the presentation or picture.

Video: The mode is suitable for playing video content.

Brightness

Press ◀▶ button to increase or decrease the level of brightness.

Contrast

Press ◀▶ button to adjust the contrast of the projected image.

Color Manager

This function can be used to adjust the colors.

Red, Green, Blue, Cyan, Magenta, Yellow can be adjusted by Hue, Saturation, Gain.

White can be adjusted by the Gain of Red, Green and Blue.

Advanced

Saturation: This function can be used to adjust the level of saturation.

Hue: This function can be used to adjust the level of hue.

Sharpness: This function can be used to adjust the sharpness, which changes the high-frequency details.

Gamma: When the ambient light is so bright that may affect the projection of the details in the dim area of the image, you can change the gamma to adjust the chrominance. The available options are 1.0, 1.8, 2.0, 2.2, 2.35, 2.5 and DICOM.



Note for DICOM:

- The DICOM option under this function can be used to enhance the gray scale level for viewing grayscale medical images, such as X-rays for training and educational purposes only.
- The projector is not a medical device and cannot be used for medical diagnosis.

Color Gamut: This function allows you to set the color display range according to application; the available options are REC709, EBU SMPTE and Native.

Color Temperature: The default of color temperature is Native, and it is suitable for most situations. As color temperature rises, the picture will appear bluer, while as the color temperature decreases, the picture will appear redder. The available options are Native, 3200K, 5400K, 6500K, 7500K and 9300K.

Input Balance: When ambient light is too bright or changes, the projected image details may be affected, you can adjust the option to make the projected colors of image closer to desired colors. There are two options for fine tuning Red, Green and Blue

Gain: These three options are used to increase or decrease the range of color input for the entire image. If minimal amount of red, green or blue appears in the gray areas, lower the gain of the corresponding color accordingly. As gain increases, the contrast of the image will become lower.

Offset: These three options will shift the color spectrum for the whole image and change its brightness, if minimal amount of red, green or blue appears in the gray areas, you can adjust the offset of the corresponding color accordingly. By increasing the offset, the image brightness will become lower.

Reset: All the settings toward Input Balance will set to default.

Uniformity

Uniformity Mode: Enable Color uniformity correction.

Location H: Select the block area from X axis.

Location V: Select the block area from Y axis.

Red Gain: Adjust the Red color gain on the selected block area.

Green Gain: Adjust the Green color gain on the selected block area.

Blue Gain: Adjust the Blue color gain on the selected block area.

Reset: All the settings toward Uniformity will set to default.

HDR

You can use this function to select a suitable HDR setting. The options are Off, Auto, PQ-400, PQ-500, PQ-1000 and HLG.

OSG Menu – ALIGNMENT

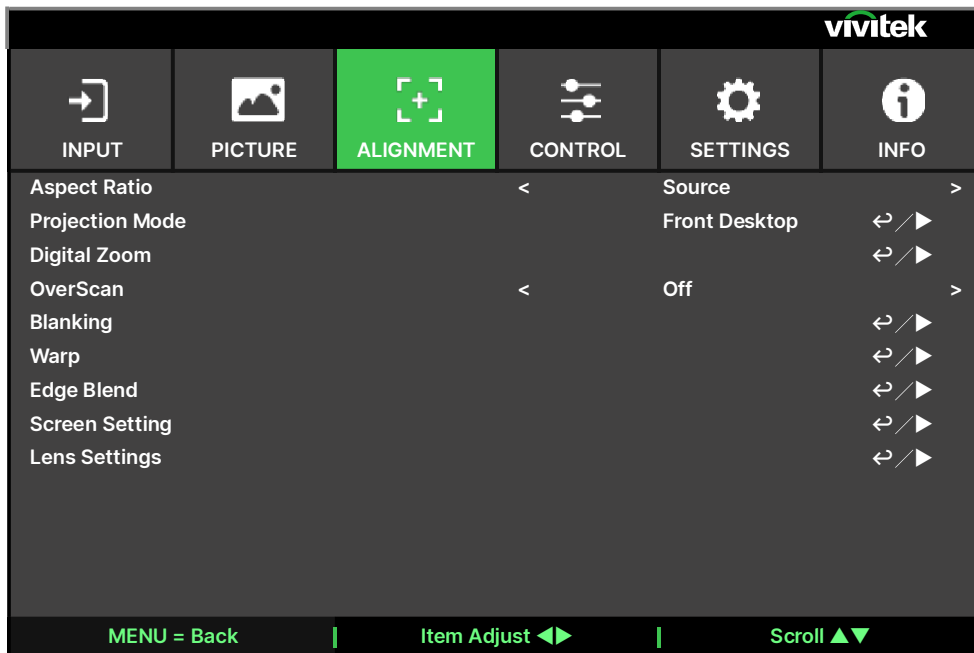

Aspect Ratio

This function allows the user to adjust the aspect ratio of the projection image by the ◀▶ button.

Projection Mode

You can use this function to select a projection mode to change the direction of the image. The selectable options are as follows:

Front Desktop: Install the projector on the desktop and project the image forward.

Rear Desktop: Install the projector on the desktop and project the image from the rear of the screen.

Front Ceiling: Mount the projector on the ceiling and project the image forward.

Rear Ceiling: Mount the projector on the ceiling and project the image from the rear of the screen.

Digital Zoom

Press ENTER button to enlarge the image or move the image.

Digital Zoom: Use the ◀▶ button to enlarge the projected image.

Digital Pan: Use the ◀▶ button to move the projected image horizontally. This function is only available when projected image is enlarged.

Digital Scan: Use the ◀▶ button to move the projected image vertically. This function is only available when projected image is enlarged.

Reset: The setting will be reset to default value.

OverScan

Noise may appear on the edge of the projected image or image may be smaller than projected image, select below option to hide the noise or extend the image.

Off: Display the original image.

Crop: Hide the edge of the image

Zoom: Extend the image to fit the projected area as possible.

Blanking

This function can adjust the edges of the image and hide surplus sections of the projection.

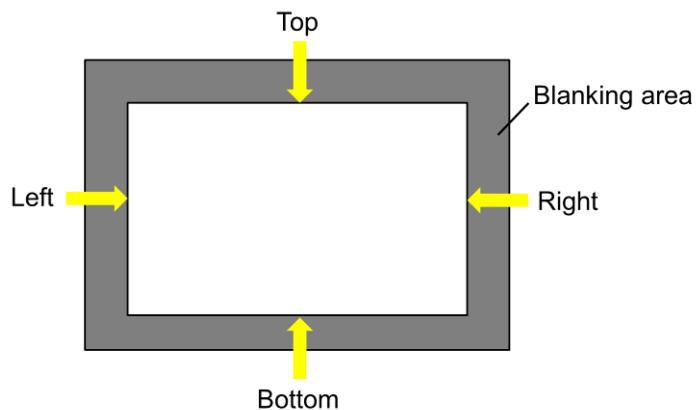

Top: Use the ◀▶ button to adjust the top blanking area on the projected picture.

Bottom: Use the ◀▶ button to adjust the bottom blanking area on the projected picture.

Left: Use the ◀▶ button to adjust the left blanking area on the projected picture.

Right: Use the ◀▶ button to adjust the right blanking area on the projected picture.

Reset: All the settings toward blanking will set to default.

Warp

This function is used to correct the distortion of image.

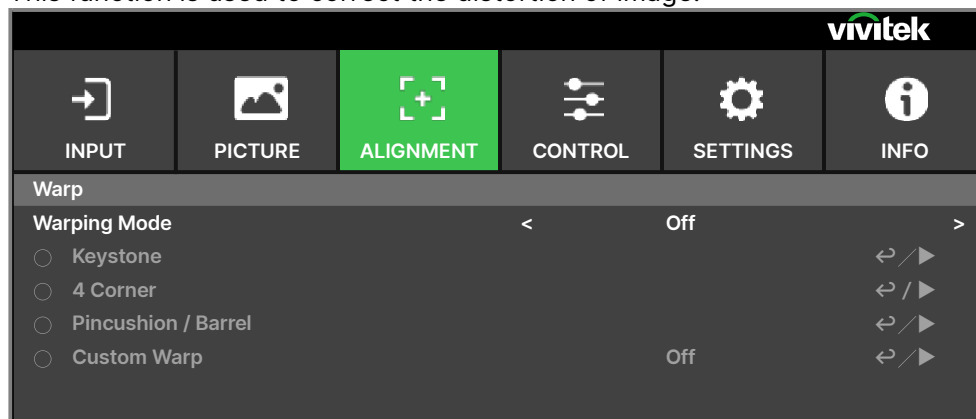

Warp Mode: 4 mode can be selected: Keystone, 4 Corner, Pincushion/Barrel and Custom Warp.

Keystone: This function is used to correct H keystone, V keystone and Rotation.

H keystone: Use the ◀▶ button to correct horizontal distortion

V keystone: Use the ◀▶ button to correct vertical distortion.

Rotation: Use the ◀▶ button to correct incorrect angle of image. Slider bar, 0.1 degree /step.

Lens Throw Ratio: Different adjustable range per lens type (number, 0.1 / step), refer to above 'Lens Type' function about the detail throw ratio definition. Example: Pana lens is 0.7 ~ 13.8.

Reset: All the settings toward Keystone will set to default.

4 Corner: This function is used to correct the image distortion that may occur in a corner due to installation or projected surface.

Top Left - H / Top Left - V: Use the ◀▶ button to correct the distortion at top-left of the picture.

Top Right - H / Top Right - V: Use the ◀▶ button to correct the distortion at top-right of the picture.

Bottom Left - H / Bottom Left - V: Use the ◀▶ button to correct the distortion at bottom-left of the picture.

Bottom Right - H / Bottom Right - V: Use the ◀▶ button to correct the distortion at bottom-right of the picture.

H Linearity: Use the ◀▶ button to adjust horizontal linearity area.

V Linearity: Use the ◀▶ button to adjust horizontal linearity area.

Reset: All the settings toward 4 Corner will set to default.

Pincushion / Barrel: This function is used to correct pincushion/barrel distortion.

Top: Use the ◀▶ button to adjust Top side distortion.

Bottom: Use the ◀▶ button to adjust Bottom side distortion.

Left: Use the ◀▶ button to adjust Left side distortion.

Right: Use the ◀▶ to adjust Right side distortion.

H keystone: Use the ◀▶ button to adjust horizontal distortion.

V keystone: Use the ◀▶ button to adjust vertical distortion.

Lens Throw Ratio: Different adjustable range per lens type (number, 0.1 / step), refer to above 'Lens Type' function about the detail throw ratio definition. Example: Pana lens is 0.7 ~ 13.8.

Reset: All the settings toward Pincushion / Barrel: will set to default.

Custom Warp: Apply the geometry adjustment using a PC projector tool.

Edge Blend

Edge Blend function requires multiple projectors to simultaneously project on the same screen. Use this function to adjust the uniformity of image. To use this function, Edge Blend must be enabled on both projectors.

Edge Blend Mode: Select On to enable this function. Following functions are available when this option is turned on; otherwise, the functions are grayed out.

Align Pattern: This function can be used to display the auxiliary lines for displaying the overlapping area; the line is moved with the value of white level you set.

Blend Start: Set the start position of overlapped area for blending.

White Level: White Level is used to set the overlapped area for blending in multi-projection application, the overlapping When projecting White, the area where the two images overlap is projected twice the projectors' white output levels. The solution is to adjust the White Level. First make sure that the units connected to the projectors are outputting black. Then increase the White Level (Top, Bottom, Left, and Right) until the non-overlap area's brightness matches the overlap area.

Black Level: The purpose of Black Level is to increase the black level of non-overlapping area. When projecting black, the area where the two images overlap projects twice the projectors' black output levels. The solution is to adjust the Black Level. First make sure that the units connected to the projectors are outputting black. Then increase the Black Level (Top, Bottom, Left, and Right) until the non-overlap area's brightness matches the overlap area.

Reset: All the settings toward edge blend will set to default.

Screen Setting: Set screen size and position.

Screen Format: Sleet the screen format to 16:10, 16:9, 4:3 and 2.35:1.

Screen Position: Adjust the position of screen.

Lens Settings

Lens Lock: This function can be used to disable lens control for preventing unauthorized operation or disoperation in lens control related functions and includes: Lens Shift, Zoom/Focus adjustment and Center Lens. It is recommend to turn on Lens Lock function to disable the Lens control after lens adjustment is done.



Important:

Turning on Lens Lock will disable lens control function including Lens Shift, Center Lens and Zoom/Focus adjustment. Please make sure Lens Lock is disabled before you perform the lens control function.

Lens Type: This projector can be used with 8 different projection lenses; the initial projection position of Ultra Short Throw (UST) Lens is different to other seven projection lenses. The projector preset two initial projection positions for these two types accordingly, Center Lens function can moves the lens to the initial position (center) automatically per the setting. Please set this option to UST Lens if Ultra Short Throw Lens is installed in the projector, otherwise please set it to non-UST Lenses.

Lens Control: Select this function to open Lens Control menu for adjustment of Zoom, Focus, or Shift. You can use the ENTER button to switch the Zoom / Focus or Shift menu. Use the ▲▼ button to adjust zoom and vertical shift of the lens, or use the ◀▶ button to adjust focus and horizontal shift of the lens.

Lens Memory: This projector supports Lens Memory function, Lens shift, Zoom and Focus memory can be stored in the projector up to 10 sets. You can load the stored memory setting to set up the lens automatically. Select Lens memory 1~10:

ENTER key to Save/Load. Press ► to switch Load/Reset state. CLEAR key to Reset.

Center Lens: This is the lens calibration function; the projector calibrates the lens shift for the precise lens memory function. After performing this function, the lens will be moved to the center position as factory default setting.

OSD Menu – CONTROL

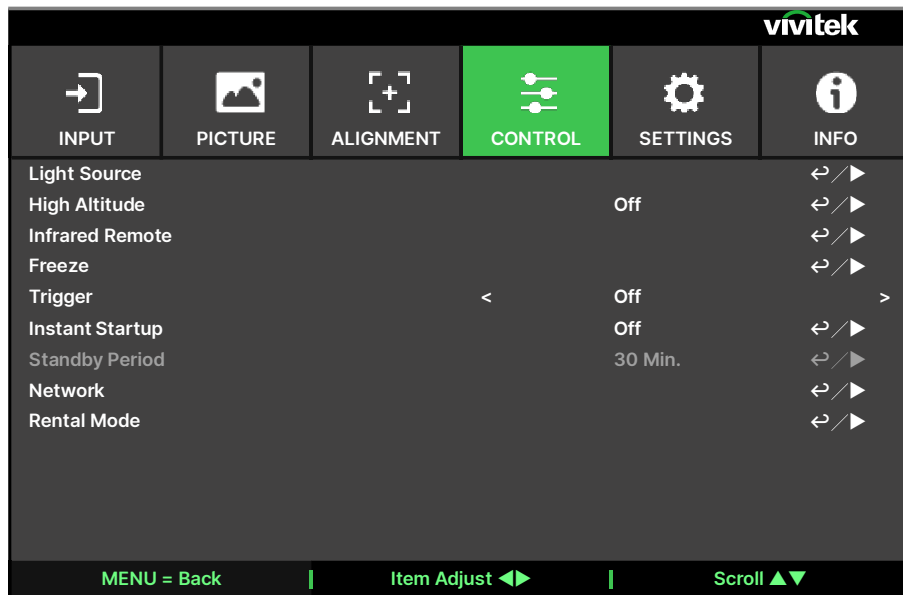

Light Source

Light Mode: When AC 220V, the Eco option will setup the initial power of light source at 70% and the Normal option will setup the initial power of light source at 100%.

When AC 110V, will be grayed-out and force the laser power output at 30% (safety consideration), the purpose of AC 110V support that just for initial install the projector when no AC 220V available yet.

Normal: Projection operating with normal light power can obtain the brightest pro-jection display.

ECO: Projection operates in the energy-saving mode, which is equivalent to 70 % power of light source.

Custom: User can decide the power level depending on his or her preference.

Custom Power Level: This function is available only when the Light Power is set to Custom, which allow to adjust the "Normal" mode range from 30% to 100%, and it cannot be selected under the Normal or Eco mode.

Constant Brightness: If select On, when the laser luminance decrease by duration of usage. The projector will add the power level automatically for getting the constant brightness. However, if power level is set to the highest brightness, this function will not achieve significant improvement.

Dynamic Black: This function can be used to enhance the black levels of the projected image dynamically per the content of the input signal if it's set to On.

Light Off Timer: If the content contains full black frames, you can enable this function and select the preferred timer to switch the light source Off-to-On dynamically. This can be used to eliminate the bright blocks of overlapping area in multi-projectors application. For example, the projection light is switched off dynamically if the timer is set to 0.5 seconds and the content contains full black frames over 0.5 seconds.

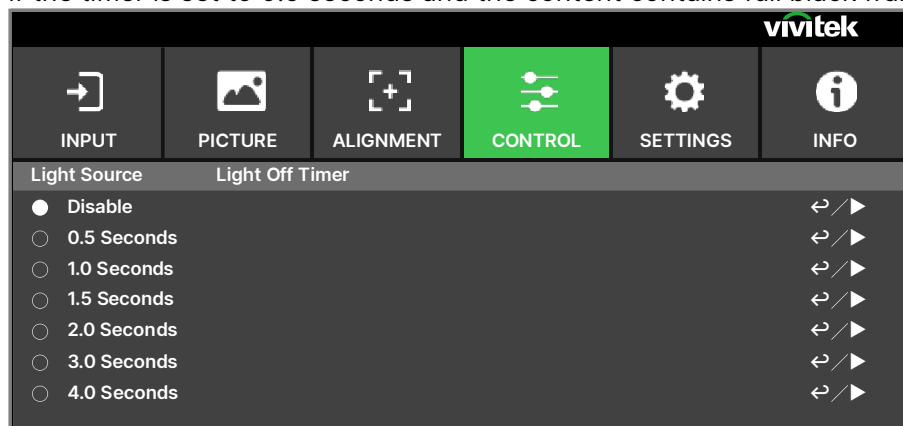

Note:

Light Off Timer is available when Dynamic Black function is turned on.

High Altitude

Use this function to adjust the cooling fan of the projector to get well cooling if the projector is installed in an area over 4000 feet. The projector is equipped with an altitude sensor which is capable of detecting atmosphere pressure for estimating altitude. If the Auto option is set to "AUTO", then the system can adjust automatically to corresponding settings that are based on an estimated altitude. If you prefer to manually set this feature, you can select On or Off.

Off: Turn off High Altitude mode if the projector is installed in an area under 4000 feet.

On: Turn on High Altitude mode if the projector is installed in an area over 4000 feet.

Auto: Set up this mode automatically by estimated altitude.



Important:

- Improper setting may cause to insufficient air flow for system cooling, then trigger system protection, please make sure the setting can match with the installation condition.
- Estimate Altitude is calculated by the atmospheric pressure. There is a tolerance when comparing to actual altitude. If any over temperature or system protection message appears, please manually adjust the High Altitude settings to On
- In some applications, regular cooling fan settings may not supply enough cold air for system cooling even when the projector is installed in an area under 4000 feet. In this case, please switch the High Altitude to On.

Infrared Remote

Remote Sensor: The default is On. However, there are three conditions that will be suggested to turn off "Remote Sensor"; the possible condition is that if the user uses wired control, he can set this function to Off, or that if the projector IR location is exposed to the bright sunlight or fluorescence, or that projector control is not controlled by remote. If the user would like to reset to On, user can only set by OSD panel or RS-232.

IR Code: Set an ID number for the projector, then set the same ID number for the remote control to match the projector ID. After ID code is set, you can control the specified projector by the remote control.

IR Code Reset: Reset the IR Code from the projector. This will revert the IR Code value to 00. Refer to the section "Using Control ID for Multi-Projector Application" on page 31.

Freeze

Freeze/unfreeze the picture on the screen.

Trigger

The projector provides a set of trigger output ports for connection to a screen. The user can connect the triggers between the screen and projector by a cable. Once the projector is powered on, the screen would be automatically turned on as well. There is a 2-3 second delay to activate this function. The selectable aspect ratios are as follows:

Off: Turn off screen trigger.

Screen: Outputs 12V of power on Trigger for whichever aspect ratio.

5:4: Outputs 12V of power on Trigger when Aspect Ratio is set to 5:4.

4:3: Outputs 12V of power on Trigger when Aspect Ratio is set to 4:3.

16:10: Outputs 12V of power on Trigger when Aspect Ratio is set to 16:10.

16:9: Outputs 12V of power on Trigger when Aspect Ratio is set to 16:9.

1.88: Outputs 12V of power on Trigger when Aspect Ratio is set to 1.88.

2.35: Outputs 12V of power on Trigger when Aspect Ratio is set to 2.35.

LetterBox: Outputs 12V of power on Trigger when Aspect Ratio is set to LetterBox.

Source: Outputs 12V of power on Trigger when Aspect Ratio is set to Source.

Native: Outputs 12V of power on Trigger when Aspect Ratio is set to Native.

RS232: Outputs 12V of power on Trigger by RS232 command control.

Instant Startup

Enable instant startup function.

Standby Period

Setting instant startup period time. Available when instant startup is On.

Network

Use this function to configure the network settings, so that you can control the projector via the network. Press the ▲▼ button and Enter button to select Network and network settings. Please refer to Remote Communication Manual for further information.

Network Setup

DHCP: Set DHCP to ON/OFF. When DHCP is set to ON, the DHCP server of the domain will assign an IP address to the projector. The IP address will appear on the IP address window without need to make any input. If the domain cannot assign any IP address, 0.0.0.0 will be shown on the IP address window.

IP Address: To specify an IP address, press the Enter button to show the IP address input window. Use the ◀▶ button to select the number in the address to change. Use the ▲▼ button to increase or decrease the number in the IP address. Network IP Address 172. xxx. xxx. xxx.

Subnet Mask: Set the subnet mask. The input method is the same as the setting for IP address.

Gateway: Set the gateway. The input method is the same as the setting for IP address.

DNS: Set the DNS. The input method is the same as the setting for IP address.

MAC Address: Shows the projector's MAC Address.

Apply: Apply the settings.

Art-Net Setup: Setup the settings of Art-Net.

Art-Net Channel Setting: Set function mapping for each channel of Art-Net.

Art-Net Channel Status: Shows current channel function mapping of Art-Net.

Rental Mode

Press ENTER and use ▲ or ▼ to scroll through submenus and enter 5 digits password.

Power Locked Level: Press ENTER and use ▲ or ▼ to scroll through submenus

Power Locked Level: To select fixed power level output (30% ~ 100%)

Power Locked Level Reset: To reset power level output to default.

Usage Locked Time: Press ENTER and use ▲ or ▼ to scroll through submenus

Usage Locked Time: To select Disable / Enable usage locked time.

Usage Time Setting(HRS): Set the usage time. There will jump out a caution window when time run out.

Expiration Time Reset: To restart and countdown the expiration time.

Change Password: Press ENTER to change the password of Rental Mode.



Note:

If want to enable Rental Mode, please contact local agent to obtain 5 digits password.

OSD Menu – SETTINGS

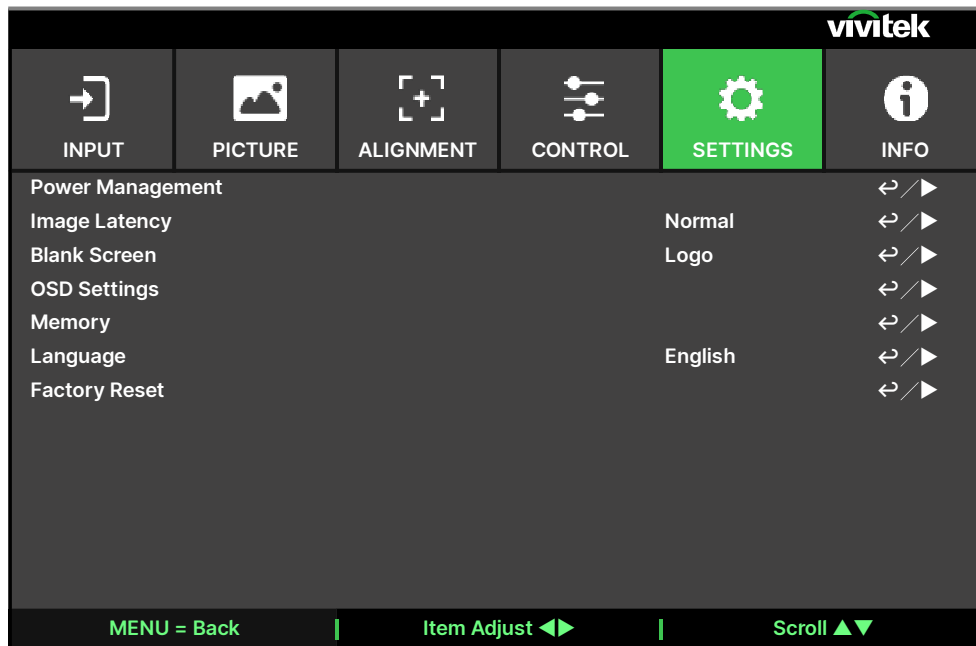

Power Management

Standby Mode: Switch standby power mode.

Auto Power Off: This function is set to OFF by default. When it is set to ON and no input signal is received within 20 minutes, the projector will turn off automatically.

Auto Power On: This function is set to OFF by default. When it is set to ON, the projector will turn on automatically when the AC power is turned on the next time. You can use this function and the power switch (instead of the remote control) to turn on the projector. Set this function to OFF if it's unnecessary.

Image Latency

This function allows you to set image latency. Note that normally the image latency should be set to Normal for best picture quality.

Normal: Set image latency to 2 frames.

Fast: Set image latency to less than 1.5 frames.

Blank Screen

User can use this function to specify the image displayed on the blank screen when there is no input signal. The selectable items are Logo, Black and Blue, the default setting is Logo.

OSD Settings

Startup Logo: Press ENTER button, and use the ◀▶ button to turn on / off the Startup Logo.

Menu Position: Adjust menu position through this function. The available position options are at Top-Left, Top-Right, Bottom-Left, Bottom-Right and center of the screen.

Menu Transparency: Changes the transparency of OSD Menu. The background color of the OSD can be adjusted from a darker solid color to a lighter transparent color.

Time Out: Set up the timer to exit OSD menu. The available options are Always On, 10 Seconds, 30 Seconds and 60 Seconds.

Message Box: This function allows you to disable the pop-up message on the bottom-right of the screen.

Menu Rotation: Adjust menu position through this function. The available position options are at Off, Clockwise, Counterclockwise of the screen.

Memory

Recall Memory: Load color image settings by previous input source memory.

Save Settings: Save color image settings by current input source.

Language

Select OSD language and choose from one of the 8 available languages options. Available languages include: English, Français, Español, Deutsch, Português, 简体中文, 繁體中文, 日本語, 한국어.

Factory Reset

Use this function to reset all the settings to factory default; light time.

OSD Menu – INFO

**Model**

Display the project model name.

Serial Number

Display the serial number of the projector.

Software Version

Display the software version in the projector including :

Control Module / Video Module / Option Module / Formatter Module / Light Module.

Laser Hours

Displays the accumulated time which the light source of the projector is used.

Signal Format

Display current input source format.

Active Source: Display the current input source information.

Timing: Display resolution.

Scanning Frequency: Display the refresh rates of the current picture.

Pixel Clock: Displays the pixel clock of the current input signal.

Color Format: Display color format RGB, YCbCr...etc.

HDR Format: Display HDR format SDR, HDR, HLG.

System Status

Display the status of system including :

AC Voltage / Altitude Mode / Laser Power / Constant Brightness.

Thermal Status

Display the status of thermal components including :

Inlet Temp. / CW Temp. / PW, TEC(DMD) Temp. / BLD 1~4 Temp. / BLD 5~8 Temp. / RLD, DMD(Ref) Temp. / All FAN Speed.

Product Specification

| | | | |
|-----------------------------------|---|-----------------------------|---------------------------------|
| Model Name | DU8055Z | DU8053Z | DU8057Z |
| Display Type | Single Chip 0.8" DLP Technology by TI | | |
| Brightness* | 16,000 Lumens | 14,000 Lumens | 24000 Lumens |
| Native Resolution | WUXGA (1920 x 1200) | | |
| Maximum Resolution | 4K UHD (3840x2160) @60Hz | | |
| Contrast Ratio | 1,300:1 (Native) / 20,000:1 (Dynamic) / 3,000,000:1 (Full On/Off) | | |
| Laser Life/Type | Up to 30,000 hours / Dual Laser Technology | | |
| Throw Ratio** | 1.4- 2.11:1 | | |
| Image Size (Diagonal) ** | 60" - 500" | | |
| Projection Distance** | 1.78 - 23.2m (5.84ft to 76.1ft) | | |
| Projection Lens** | F = 1.8 | | |
| Zoom Ratio** | 1.51:1 | | |
| Aspect Ratio | 16:10 | | |
| Offset | Motorized Lens Shift | | |
| Lens Shift Range** | Vertical: ±60%, Horizontal: ±20% | | |
| Keystone Correction | Horizontal ±60°, Vertical ±40° (Adjustable Range of Single Direction) | | |
| Horizontal Frequency | 23.67 ~ 135 kHz | | |
| Vertical Scan Rate | 24~30Hz ;47~120Hz | | |
| Edge Blending | Yes (Built-In) | | |
| Warping | Yes (Built-In) | | |
| 3D Functionality | Yes (DLP® Link™, HDMI v2.0 Blu-ray, side by side, frame packing, top and bottom, frame sequential) | | |
| Computer Compatibility | VGA, SVGA, XGA, WXGA, SXGA, SXGA+, UXGA, 1080P, WUXGA, 4k UHD@60hz, Mac | | |
| Video Compatibility | SDTV (480i, 576i), EDTV (480p, 576p), HDTV (720p, 1080i/p, 4K UHD) | | |
| I/O Connection Ports | HDMI v2.0 x2 (HDCP v2.2 Compliant), Display Port 1.2 x2, RS232-In/Out, 12v Trigger, Wired Remote In/Out, USB 5V/2A, HDBaseT™x1 (VS2000) (100Mbps), LAN(RJ45)(10/100Mbps) x1 DVI-D x1, 3D Sync In/Out, 3D IR Sync Out x1, 3G SDI-In/Out | | |
| Projection Method | Table Top, Ceiling Mount, Portrait (Front or Rear) | | |
| Dimensions (WxDxH) | 500 x 591 x 216mm (19.7" x 23.3" x 8.5") | | |
| Weight | 29.4kg (64.8lbs)(w/o Lens) | | 30kg (66.1lbs)(w/o Lens) |
| Available Colors | Black | | |
| Noise Level | 39dB / 36dB (Normal / Eco Mode) | | 44dB / 39dB (Normal / Eco Mode) |
| Power Supply | AC 100-240V, 50/60Hz | | AC 110-240V, 50/60Hz |
| Power Consumption | 950W@110Vac, 900W@240Vac | 860W@110Vac, 830W@240Vac | 1200W@110Vac, 1400W@240Vac |
| | Less than 0.5W (Network Off), Less than 3W (Network On) | | |
| Environmental Operation Condition | At Temperature 0°C to 40°C, Relative Humidity 10~85% (with maximum temperature of 35°C), Non-Condensation | | |
| Environmental Storage Condition | At Temperature -20°C to 60°C, Relative Humidity 10% to 90%, Non-Condensation | | |
| Standard Accessories | AC Power Cord, Remote Control w/Batteries, Remote Control Cable, Documentation Kit | | |
| Optional Accessories | Interchangeable Lens Options (x8) T/R 0.31 ~ 0.33:1, T/R 0.55 ~ 0.75:1, T/R 0.74 ~ 1.08:1, T/R 1.05 ~ 1.41:1, T/R 1.4 ~ 2.11:1, T/R 2.1 ~ 4.0:1, T/R 3.0 ~ 4.52:1, T/R 4.46 ~ 6.94:1 | | |

Note:

DU8057Z @ 110Vac is reduced **10%** in power.

*** Brightness specifications follow ISO 21118 standards

*** with Standard Lens

| | | |
|-----------------------------------|--|-------------------------------|
| Model Name | DK8155Z | DK8150Z |
| Display Type | Single Chip 0.8" DLP Technology by TI | |
| Brightness* | 15,000 Lumens | 12000 Lumens |
| Native Resolution | 4K UHD (3840x2400) | |
| Maximum Resolution | 4K UHD+ | |
| Contrast Ratio | 1,300:1 (Native) / 20,000:1 (Dynamic) / 3,000,000:1 (Full On/Off) | |
| Laser Life/Type | Up to 30,000 hours / Dual Laser Technology | |
| Throw Ratio** | 1.4- 2.11:1 | |
| Image Size (Diagonal) ** | 60" - 500" | |
| Projection Distance** | 1.78 - 23.2m (5.84ft to 76.1ft) | |
| Projection Lens** | F = 1.8 | |
| Zoom Ratio** | 1.51:1 | |
| Aspect Ratio | 16:10 | |
| Offset | Motorized Lens Shift | |
| Lens Shift Range** | Vertical: ±60%, Horizontal: ±20% | |
| Keystone Correction | Horizontal ±60°, Vertical ±40° (Adjustable Range of Single Direction) | |
| Horizontal Frequency | 23.67 ~ 135 kHz | |
| Vertical Scan Rate | 24~30Hz ;47~120Hz | |
| Edge Blending | Yes (Built-In) | |
| Warping | Yes (Built-In) | |
| 3D Functionality | Yes (DLP® Link™, HDMI v2.0 Blu-ray, side by side, frame packing, top and bottom, frame sequential) | |
| Computer Compatibility | VGA, SVGA, XGA, WXGA, SXGA, SXGA+, UXGA, 1080P, WUXGA, 4k UHD@60hz, Mac | |
| Video Compatibility | SDTV (480i, 576i), EDTV (480p, 576p), HDTV (720p, 1080i/p, 4K UHD) | |
| I/O Connection Ports | HDMI v2.0 x2 (HDCP v2.2 Compliant), Display Port 1.2 x2, RS232-In/Out, 12v Trigger, Wired Remote In/Out, USB 5V/2A, HDBaseT™x1 (VS2000) (100Mbps), LAN(RJ45)(10/100Mbps) x1 DVI-D x1, 3D Sync In/Out, 3D IR Sync Out x1, 12G SDI-In/Out | |
| Projection Method | Table Top, Ceiling Mount, Portrait (Front or Rear) | |
| Dimensions (WxDxH) | 500 x 591 x 216mm (19.7" x 23.3" x 8.5") | |
| Weight | 29.4kg (64.8lbs)(w/o Lens) | |
| Available Colors | Black | |
| Noise Level | 39dB / 36dB (Normal / Eco Mode) | 37dB/35dB (Normal / Eco Mode) |
| Power Supply | AC 100-240V, 50/60Hz | |
| Power Consumption | 1024W@110Vac, 990W@240Vac | 770W @110Vac, 720W @220Vac |
| | Less than 0.5W (Network Off), Less than 3W (Network On) | |
| Environmental Operation Condition | At Temperature 0°C to 40°C, Relative Humidity 10~85% (with maximum temperature of 35°C), Non-Condensation | |
| Environmental Storage Condition | At Temperature -20°C to 60°C, Relative Humidity 10% to 90%, Non-Condensation | |
| Standard Accessories | AC Power Cord, Remote Control w/Batteries, Remote Control Cable, Documentation Kit | |
| Optional Accessories | Interchangeable Lens Options (x8) T/R 0.31 ~ 0.33:1, T/R 0.55 ~ 0.75:1, T/R 0.74 ~ 1.08:1, T/R 1.05 ~ 1.41:1, T/R 1.4 ~ 2.11:1, T/R 2.1 ~ 4.0:1, T/R 3.0 ~ 4.52:1, T/R 4.46 ~ 6.94:1 | |

Supported Signal Input Timing

| Signal Format | Resolution | H Freq. (KHz) | Frame Rate (Hz) | PCLK (MHz) | DisplayPort | HDMI / HDBaseT | | | | DVI |
|---------------|--------------|---------------|-----------------|------------|-------------|----------------|-----------|------------|------------|-----|
| | | | | | | RGB | YUV 8-bit | YUV 10-bit | YUV 12-bit | |
| PC | 640x480 | 31.469 | 59.94 | 25.175 | ○ | ○ | | | | ○ |
| | 640x480 | 37.500 | 74.99 | 31.500 | ○ | ○ | | | | ○ |
| | 640x480 | 43.269 | 85 | 36.000 | ○ | ○ | | | | ○ |
| | 800x600 | 37.879 | 60.32 | 40.000 | ○ | ○ | | | | ○ |
| | 800x600 | 46.875 | 75 | 49.500 | ○ | ○ | | | | ○ |
| | 800x600 | 53.674 | 85.06 | 56.250 | ○ | ○ | | | | ○ |
| | 848x480 | 23.674 | 47.95 | 25.000 | | ○ | | | | ○ |
| | 848x480 | 31.020 | 60 | 33.750 | ○ | ○ | | | | ○ |
| | 1024x768 | 48.363 | 60 | 65.000 | ○ | ○ | | | | ○ |
| | 1024x768 | 56.476 | 70.07 | 75.000 | ○ | ○ | | | | ○ |
| | 1024x768 | 60.023 | 75 | 78.750 | ○ | ○ | | | | ○ |
| | 1024x768 | 68.677 | 85 | 94.500 | ○ | ○ | | | | ○ |
| | 1152x864 | 67.5 | 75 | 108.000 | ○ | ○ | | | | ○ |
| | 1280x720 | 35.531 | 47.95 | 57.987 | ○ | ○ | | | | ○ |
| | 1280x768 | 47.776 | 60 | 79.500 | ○ | ○ | | | | ○ |
| | 1280x768 | 60.289 | 74.89 | 102.250 | ○ | ○ | | | | ○ |
| | 1280x768 | 68.633 | 84.84 | 117.500 | ○ | ○ | | | | ○ |
| | 1280x800 | 49.702 | 60 | 83.500 | ○ | ○ | | | | ○ |
| | 1280x800 | 62.795 | 74.93 | 106.500 | ○ | ○ | | | | ○ |
| | 1280x960 | 60.000 | 60 | 108.000 | ○ | ○ | | | | ○ |
| | 1280x960 | 85.938 | 85 | 148.500 | ○ | ○ | | | | ○ |
| | 1280x1024 | 63.981 | 60.02 | 108.000 | ○ | ○ | | | | ○ |
| | 1280x1024 | 79.976 | 75.02 | 135.000 | ○ | ○ | | | | ○ |
| | 1280x1024 | 91.146 | 85.02 | 157.500 | ○ | ○ | | | | ○ |
| | 1366x768 | 47.712 | 60 | 85.500 | ○ | ○ | | | | ○ |
| | 1440x900 | 55.935 | 59.89 | 106.500 | ○ | ○ | | | | ○ |
| | 1440x900 | 70.635 | 74.98 | 136.750 | ○ | ○ | | | | ○ |
| | 1400x1050 | 65.317 | 60 | 121.750 | ○ | ○ | | | | ○ |
| | 1400x1050 | 82.278 | 74.87 | 156.000 | ○ | ○ | | | | ○ |
| | 1600x900 | 55.92 | 60 | 119.000 | ○ | ○ | | | | ○ |
| | 1600x1200 | 75.000 | 60 | 162.000 | ○ | ○ | | | | ○ |
| | 1680x1050 | 65.290 | 60 | 146.250 | ○ | ○ | | | | ○ |
| | 1920x1080 | 53.225 | 47.95 | 135.403 | ○ | ○ | | | | ○ |
| | 1920x1200 RB | 58.894 | 47.96 | 122.500 | ○ | ○ | | | | ○ |
| | 1920x1200 | 61.816 | 50 | 158.250 | ○ | ○ | | | | ○ |
| | 1920x1200 RB | 74.038 | 60 | 154.000 | ○ | ○ | | | | ○ |
| 2048x1152 RB | 72.000 | 60 | 162.000 | ○ | | | | | | |
| 2560x1600 RB | 98.713 | 59.97 | 268.500 | ○ | | | | | | |

| Signal Format | Resolution | H Freq. (KHz) | Frame Rate (Hz) | PCLK (MHz) | DisplayPort | HDMI / HDBaseT | | | | DVI |
|---------------|--------------|---------------|-----------------|------------|-------------|----------------|-----------|------------|------------|-----|
| | | | | | | RGB | YUV 8-bit | YUV 10-bit | YUV 12-bit | |
| Apple Mac | 640x480 | 35.000 | 66.67 | 30.240 | ○ | ○ | | | | |
| | 832x624 | 49.720 | 74.55 | 57.280 | ○ | ○ | | | | |
| | 1024x768 | 60.241 | 74.93 | 80.000 | ○ | ○ | | | | |
| | 1152x870 | 68.861 | 75.06 | 100.000 | ○ | ○ | | | | |
| EDTV | 480p | 31.469 | 59.94 | 27.000 | ○ | ○ | ○ | ○ | ○ | |
| | 576p | 31.250 | 50 | 27.000 | ○ | ○ | ○ | ○ | ○ | |
| HDTV | 1080i | 28.125 | 50 | 74.250 | ○ | ○ | ○ | ○ | ○ | |
| | 1080i | 33.716 | 59.94 | 74.176 | ○ | ○ | ○ | ○ | ○ | |
| | 1080i | 33.750 | 60 | 74.250 | ○ | ○ | ○ | ○ | ○ | |
| | 720p | 37.500 | 50 | 74.250 | ○ | ○ | ○ | ○ | ○ | |
| | 720p | 44.955 | 59.94 | 74.176 | ○ | ○ | ○ | ○ | ○ | |
| | 720p | 45.000 | 60 | 74.250 | ○ | ○ | ○ | ○ | ○ | |
| | 1080p | 26.973 | 23.98 | 74.176 | ○ | ○ | ○ | ○ | ○ | |
| | 1080p | 27.000 | 24 | 74.250 | ○ | ○ | ○ | ○ | ○ | |
| | 1080p | 28.125 | 25 | 74.250 | ○ | ○ | ○ | ○ | ○ | |
| | 1080p | 33.716 | 29.97 | 74.176 | ○ | ○ | ○ | ○ | ○ | |
| | 1080p | 33.750 | 30 | 74.250 | ○ | ○ | ○ | ○ | ○ | |
| | 1080p | 56.250 | 50 | 148.500 | ○ | ○ | ○ | ○ | ○ | |
| | 1080p | 67.433 | 59.94 | 148.352 | ○ | ○ | ○ | ○ | ○ | |
| | 1080p | 67.500 | 60 | 148.500 | ○ | ○ | ○ | ○ | ○ | |
| | 3840x2160 | 53.946 | 23.97 | 296.703 | ○ | ○ | ○ | ○ | ○ | |
| | 3840x2160 | 54.000 | 24 | 297 | ○ | ○ | ○ | ○*3 | ○*3 | |
| | 3840x2160 | 56.250 | 25 | 297 | ○ | ○ | ○ | ○*3 | ○*3 | |
| | 3840x2160 | 67.500 | 29.97 | 296.703 | ○ | ○ | ○ | ○ | ○ | |
| | 3840x2160 | 67.500 | 30 | 297 | ○ | ○ | ○ | ○*3 | ○*3 | |
| | 3840x2160 | 112.500 | 50 | 594 | ○ | ○ | ○*4 | ○*1*5 | ○*1*5 | |
| | 3840x2160 | 135.000 | 60 | 594 | ○ | ○ | ○*4 | ○*1*5 | ○*1*5 | |
| | 4096x2160 *2 | 54.000 | 24 | 297 | ○ | ○ | ○ | ○ | ○ | |
| | 4096x2160 *2 | 56.250 | 25 | 297 | ○ | ○ | ○ | ○ | ○ | |
| | 4096x2160 *2 | 67.500 | 30 | 297 | ○ | ○ | ○ | ○ | ○ | |
| 4096x2160 *2 | 112.500 | 50 | 594 | ○ | ○ | ○ | ○*1 | ○*1 | | |
| 4096x2160 *2 | 135.000 | 60 | 594 | ○ | ○ | ○ | ○*1 | ○*1 | | |

*1: color mode is YUV422 or YUV420

*2: Not available in HDBaseT format.

*3: HDBaseT supports 4K 24/25/30Hz 422 only.

*4: HDBaseT supports 4K 50/60Hz 420 8-bit only.

*5: HDMI 1,2 support up to 422, HDBaseT does not support.

SDI (SDI Format)

| Timing | SDI Link mode | Signal Standards | Color Encode | Sampling Structure | Bit Depth |
|---------------------|-------------------------|-----------------------|--------------|--------------------|-----------|
| 1080i59 | HD | SMPTE 292M 1.5Gbps HD | YCbCr | 4:2:2 | 10 |
| 1080i50 | HD | SMPTE 292M 1.5Gbps HD | YCbCr | 4:2:2 | 10 |
| 1080i60 | HD | SMPTE 292M 1.5Gbps HD | YCbCr | 4:2:2 | 10 |
| 720p24 | HD | SMPTE 292M 1.5Gbps HD | YCbCr | 4:2:2 | 10 |
| 720p25 | HD | SMPTE 292M 1.5Gbps HD | YCbCr | 4:2:2 | 10 |
| 720p30 | HD | SMPTE 292M 1.5Gbps HD | YCbCr | 4:2:2 | 10 |
| 720p50 | HD | SMPTE 292M 1.5Gbps HD | YCbCr | 4:2:2 | 10 |
| 720p60 | HD | SMPTE 292M 1.5Gbps HD | YCbCr | 4:2:2 | 10 |
| 1080p24 | HD | SMPTE 292M 1.5Gbps HD | YCbCr | 4:2:2 | 10 |
| 1080p25 | HD | SMPTE 292M 1.5Gbps HD | YCbCr | 4:2:2 | 10 |
| 1080p30 | HD | SMPTE 292M 1.5Gbps HD | YCbCr | 4:2:2 | 10 |
| 1080p50 | 3G Level A | SMPTE 424M 3Gbps | YCbCr | 4:2:2 | 10 |
| 1080p59 | 3G Level A | SMPTE 424M 3Gbps | YCbCr | 4:2:2 | 10 |
| 1080p60 | 3G Level A | SMPTE 424M 3Gbps | YCbCr | 4:2:2 | 10 |
| 2160p24 (3840x2160) | 6G (Single Link) | SMPTE 2081 6Gbps | YCbCr | 4:2:2 / 4:2:0 | 10 |
| 2160p25 (3840x2160) | 6G (Single Link) | SMPTE 2081 6Gbps | YCbCr | 4:2:2 / 4:2:0 | 10 |
| 2160p30 (3840x2160) | 6G (Single Link) | SMPTE 2081 6Gbps | YCbCr | 4:2:2 / 4:2:0 | 10 |
| 2160p24 (4096x2160) | 6G (Single Link) | SMPTE 2081 6Gbps | YCbCr | 4:2:2 | 10 |
| 2160p25 (4096x2160) | 6G (Single Link) | SMPTE 2081 6Gbps | YCbCr | 4:2:2 | 10 |
| 2160p30 (4096x2160) | 6G (Single Link) | SMPTE 2081 6Gbps | YCbCr | 4:2:2 | 10 |
| 2160p24 (3840x2160) | 12G (Single Link - 2SI) | SMPTE 2082 12Gbps | YCbCr | 4:2:2 / 4:4:4 | 10/12 |
| 2160p25 (3840x2160) | 12G (Single Link - 2SI) | SMPTE 2082 12Gbps | YCbCr | 4:2:2 / 4:4:4 | 10/12 |
| 2160p30 (3840x2160) | 12G (Single Link - 2SI) | SMPTE 2082 12Gbps | YCbCr | 4:2:2 / 4:4:4 | 10/12 |
| 2160p24 (4096x2160) | 12G (Single Link - 2SI) | SMPTE 2082 12Gbps | YCbCr | 4:2:2 / 4:4:4 | 10/12 |
| 2160p25 (4096x2160) | 12G (Single Link - 2SI) | SMPTE 2082 12Gbps | YCbCr | 4:2:2 / 4:4:4 | 10/12 |
| 2160p30 (4096x2160) | 12G (Single Link - 2SI) | SMPTE 2082 12Gbps | YCbCr | 4:2:2 / 4:4:4 | 10/12 |
| 2160p50 (3840x2160) | 12G (Single Link - 2SI) | SMPTE 2082 12Gbps | YCbCr | 4:2:2 | 10 |
| 2160p60 (3840x2160) | 12G (Single Link - 2SI) | SMPTE 2082 12Gbps | YCbCr | 4:2:2 | 10 |
| 2160p50 (4096x2160) | 12G (Single Link - 2SI) | SMPTE 2082 12Gbps | YCbCr | 4:2:2 | 10 |
| 2160p60 (4096x2160) | 12G (Single Link - 2SI) | SMPTE 2082 12Gbps | YCbCr | 4:2:2 | 10 |

Supported 3D Signal

| Standard | | Resolution | V-Freq (Hz) | V-Total | H-Freq (kHz) | HDMI | DisplayPort | Dual Channel | | Output Display Frame Rate |
|--------------|---------------------|------------|-------------|---------|--------------|------|-------------|--------------|-----------------|---------------------------|
| | | | | | | | | HDMI 1/2 | DisplayPort 1/2 | |
| 720p50 | Frame Packing | 1280x720 | 50.00 | 1470 | 37.50 | ○ | | | | 100 |
| 720p59 | Frame Packing | 1280x720 | 59.94 | 1470 | 44.96 | ○ | | | | 120 |
| 720p60 | Frame Packing | 1280x720 | 60.00 | 1470 | 45.00 | ○ | | | | 120 |
| 720p50 | Top-and-Bottom | 1280x720 | 50.00 | 750 | 37.50 | ○ | ○ | | | 100 |
| 720p59 | Top-and-Bottom | 1280x720 | 59.94 | 750 | 44.96 | ○ | ○ | | | 120 |
| 720p60 | Top-and-Bottom | 1280x720 | 60.00 | 750 | 45.00 | ○ | ○ | | | 120 |
| 1080p23 | Frame Packing | 1920x1080 | 23.98 | 2205 | 26.97 | ○ | | | | 144 |
| 1080p24 | Frame Packing | 1920x1080 | 24.00 | 2205 | 27.00 | ○ | | | | 144 |
| 1080i50 | Side-by-Side (Half) | 1920x1080 | 50.00 | 1125 | 56.25 | ○ | ○ | | | 100 |
| 1080i59 | Side-by-Side (Half) | 1920x1080 | 59.94 | 1125 | 67.43 | ○ | ○ | | | 120 |
| 1080i60 | Side-by-Side (Half) | 1920x1080 | 60.00 | 1125 | 67.50 | ○ | ○ | | | 120 |
| 1080p50 | Side-by-Side (Half) | 1920x1080 | 50.00 | 1125 | 56.25 | ○ | ○ | | | 100 |
| 1080p59 | Side-by-Side (Half) | 1920x1080 | 59.94 | 1125 | 67.43 | ○ | ○ | | | 120 |
| 1080p60 | Side-by-Side (Half) | 1920x1080 | 60.00 | 1125 | 67.50 | ○ | ○ | | | 120 |
| 1080p50 | Top-and-Bottom | 1920x1080 | 50.00 | 1125 | 56.25 | ○ | ○ | | | 100 |
| 1080p59 | Top-and-Bottom | 1920x1080 | 59.94 | 1125 | 67.43 | ○ | ○ | | | 120 |
| 1080p60 | Top-and-Bottom | 1920x1080 | 60.00 | 1125 | 67.50 | ○ | ○ | | | 100 |
| 1080p50 | Frame Sequential | 1920x1080 | 50.00 | 1125 | 56.25 | ○ | ○ | | | 100 |
| 1080p59 | Frame Sequential | 1920x1080 | 59.94 | 1125 | 67.43 | ○ | ○ | | | 120 |
| 1080p60 | Frame Sequential | 1920x1080 | 60.00 | 1125 | 67.50 | ○ | ○ | | | 120 |
| WUXGA_100_RB | Frame Sequential | 1920x1200 | 100.00 | 1258 | 125.72 | ○ | ○ | | | 100 |
| WUXGA_120_RB | Frame Sequential | 1920x1200 | 120.00 | 1271 | 152.40 | ○ | ○ | | | 120 |
| 1080p50 | Dual Pipe | 1920x1080 | 50.00 | 1125 | 56.25 | | | ○ | ○ | 100 |
| 1080p59 | Dual Pipe | 1920x1080 | 59.94 | 1125 | 67.43 | | | ○ | ○ | 120 |
| 1080p60 | Dual Pipe | 1920x1080 | 60.00 | 1125 | 67.50 | | | ○ | ○ | 120 |
| WUXGA_60_RB | Dual Pipe | 1920x1200 | 60.00 | 1235 | 74.04 | | | ○ | ○ | 120 |

Configurations of Terminals

DVI-D Terminal

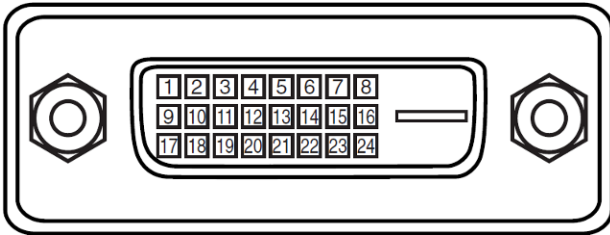

| | | | |
|----|------------------------|----|------------------------|
| 1 | T.M.D.S. Data 2- Input | 13 | N.C |
| 2 | T.M.D.S. Data 2+ Input | 14 | P5V |
| 3 | Ground | 15 | Ground |
| 4 | N.C | 16 | HPD |
| 5 | N.C | 17 | T.M.D.S. Data 0- Input |
| 6 | SCL | 18 | T.M.D.S. Data 0+ Input |
| 7 | SDA | 19 | Ground |
| 8 | N.C | 20 | N.C |
| 9 | T.M.D.S. Data 1- Input | 21 | N.C |
| 10 | T.M.D.S. Data 1+ Input | 22 | Ground |
| 11 | Ground | 23 | T.M.D.S. Clock+ Input |
| 12 | N.C | 24 | T.M.D.S. Clock- Input |

Serial Control Terminal (RS-232, D-sub 9 pin)

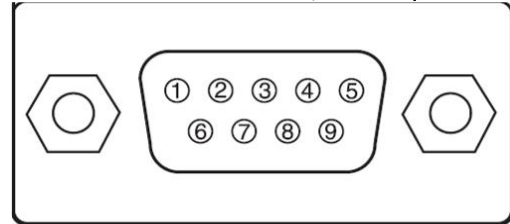

| Serial | |
|--------|-----------------|
| 1 | N.C |
| 2 | RXD |
| 3 | TXD |
| 4 | N.C |
| 5 | Ground |
| 6 | N.C |
| 7 | Short with pin8 |
| 8 | Short with pin7 |
| 9 | N.C |

HDMI(19 pin Type A)

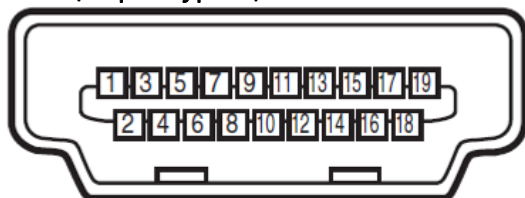

| | | | |
|----|-------------------------|----|-------------------------|
| 1 | T.M.D.S. Data 2+ Input | 11 | Ground |
| 2 | Ground | 12 | T.M.D.S. Clock C- Input |
| 3 | T.M.D.S. Data 2- Input | 13 | CEC |
| 4 | T.M.D.S. Data 1+ Input | 14 | N.C |
| 5 | Ground | 15 | SCL |
| 6 | T.M.D.S. Data 1- Input | 16 | SDA |
| 7 | T.M.D.S. Data 0+ Input | 17 | Ground |
| 8 | Ground | 18 | P5V |
| 9 | T.M.D.S. Data 0- Input | 19 | HPD |
| 10 | T.M.D.S. Clock C+ Input | | |

HDBaseT/LAN Terminal (RJ-45)

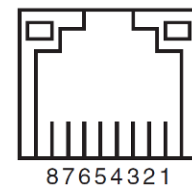

| 87654321 | |
|----------|--------|
| 1 | TX+ |
| 2 | TX- |
| 3 | TXC |
| 4 | Ground |
| 5 | Ground |
| 6 | RXC |
| 7 | RX+ |
| 8 | RX- |

Screen Trigger

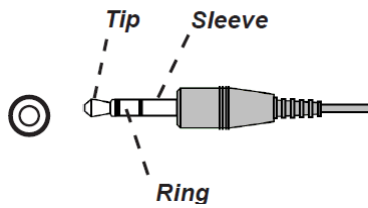

| | | |
|---|---------|----------|
| 1 | Tip | VCC(12V) |
| 2 | Sleeve- | Ground |
| 3 | Ring | Signal |

Wired Remote

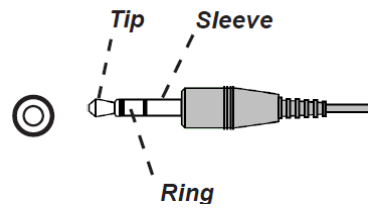

| | | |
|---|---------|-----------|
| 1 | Tip | VCC(3.3V) |
| 2 | Sleeve- | Ground |
| 3 | Ring | Signal |

3D Sync Out

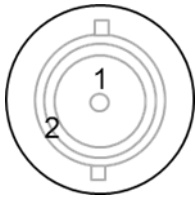

| | |
|---|--------|
| 1 | Signal |
| 2 | Ground |

Lens Series

Eight types of optional electric lenses are available for the projector and are listed in the below table. Contact an authorized Vivitek dealer for additional details.

| Part Number | Lens Name | F Number | Focal Length | Zoom Ratio | Screen Size | Throw Ratio | Release Date |
|-------------|-------------------------------|-------------|-----------------|------------|-------------|-----------------|---|
| D89-UST01 | Ultra short throw Lens L-type | 2.05 - 2.06 | 5.8 - 6.14mm | 1.06:1 | 80" - 300" | T/R 0.31 - 0.33 | Estimated launch in Q2 2025, please confirm with local sales for actual information |
| D89-UWZ01 | Short Throw Lens | 2.03 - 2.34 | 10.03 - 13.54mm | 1.36:1 | 80" - 300" | T/R 0.55 - 0.75 | |
| D89-UWZ02 | Short Throw Lens | 2.02 - 2.33 | 13.47 - 19.67mm | 1.46:1 | 60" - 400" | T/R 0.74 - 1.08 | |
| D89-WZ01 | Wide zoom | 1.9 - 2.08 | 18.78 - 25.3mm | 1.34:1 | 60" - 500" | T/R 1.05 - 1.41 | |
| D89-ST01 | Standard Lens | 1.8 - 2.11 | 25.04 - 37.57mm | 1.5:1 | 60" - 500" | T/R 1.4 - 2.11 | |
| D89-SMLZ01 | Longer Zoom Lens | 1.9 - 2.44 | 37.23 - 47.06mm | 1.9:1 | 60" - 500" | T/R 2.1 - 4 | |
| D88-LOZ101 | Long Zoom Lens 1 | 1.85 - 2.41 | 52.8 - 79.1mm | 1.5 | 50" - 300" | T/R 3.0 - 4.52 | |
| D88-LOZ201 | Long Zoom Lens 2 | 1.85 - 2.48 | 78.5 - 121.9mm | 1.55 | 50" - 300" | T/R 4.46 - 6.94 | |

Product Dimensions

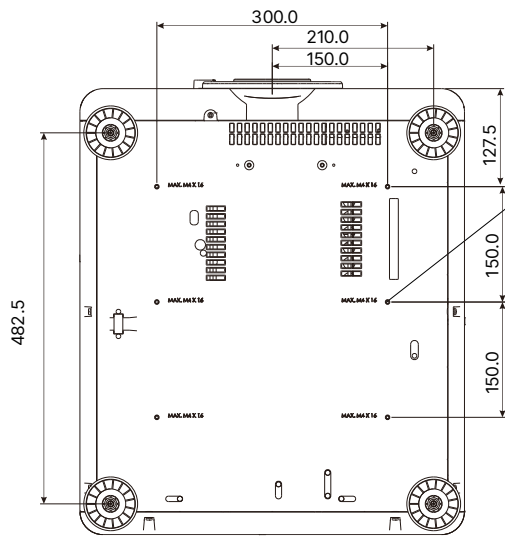
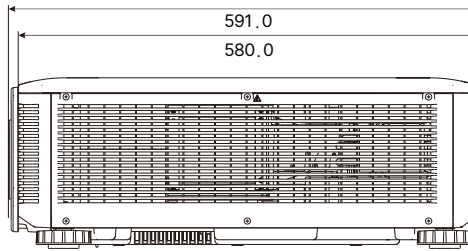
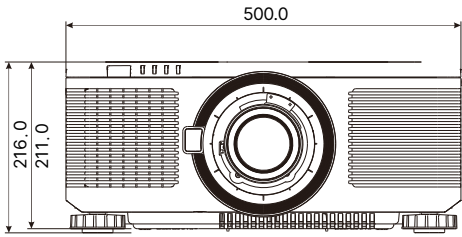

6-Mounting holes
M4 MAX. Length L=16mm

LED Indication

Several indicators messages are used to display the current projector status or alert the abnormal message.

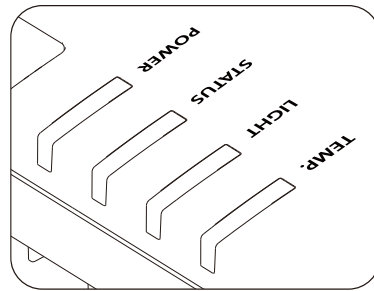

TEMP LED Indicator

| LED Color and Status | Pattern Sequence | Condition Description |
|---------------------------|------------------|-----------------------|
| Off (No color) | | No Error |
| RED, continuous flashing. | | Temperature Error |

LIGHT LED Indicator

| LED Color and Status | Pattern Sequence | Condition Description |
|-----------------------------|------------------|---|
| Off (No color) | | Light source is off. |
| ORANGE, solid on. | | Light source be run on Forced Eco mode when high temperature. |
| GREEN, solid on. | | Light source is normal running. |
| GREEN, repeat flash 1 time. | | Light source is temporary off by SHUTTER ON (Closed). |
| RED, repeat flash 1 time. | | Light source can't be ignited when warm up phase. |
| RED, repeat flash 2 times. | | Light source be extinguished during normal operation. |

STATUS LED Indicator

| LED Color and Status | Pattern Sequence | Condition Description |
|-------------------------------|------------------|---|
| Off (No color) | | No Error |
| ORANGE, repeat flash 2 times. | | Request to re-execute the Lens Calibration process. |
| GREEN, repeat flash 2 times. | | Lens calibration is processing. |
| RED, repeat flash 1 time. | | Cover Error |
| RED, repeat flash 2 times. | | TEC/Color sensor Problem |
| RED, repeat flash 4 times. | | Fan Error |
| ORANGE, solid on. | | Firmware Upgrade mode |
| RED, solid on. | | System Error |

POWER LED Indicator

| LED Color and Status | Pattern Sequence | Condition Description |
|------------------------------|------------------|---|
| Off (No color) | | AC Power is off |
| GREEN, continuous flashing. | | Projector is powering up |
| ORANGE, continuous flashing. | | Projector is cooling down to standby mode |
| RED, solid on. | | Standby Mode: Power Saving without network control capability |
| ORANGE, solid on. | | Standby Mode: with Network control capability. |
| GREEN, solid on. | | Projector is power on |



Note:

1. Each cell of 'Pattern Sequence' indicates 0.5 second period.
2. Gray color cell indicates the LED indicator is state on off (no color).

Common Problems and Solutions

These guidelines provide tips to deal with problems you may encounter while using the projector. If the problem remains unsolved, contact your dealer for assistance.

Often the problem is something as simple as a loose connection. Check the following before proceeding to the problem-specific solutions.

- Use some other electrical device to confirm that the electrical outlet is working.
- Ensure the projector is turned on.
- Ensure all connections are securely attached.
- Ensure the attached device is turned on.
- Ensure a connected PC is not in suspending mode.
- Ensure a connected notebook computer is configured for an external display. (This is usually done by pressing an Fn-key combination on the notebook.)

Tips for Troubleshooting

- In each problem-specific section, try the steps in the order suggested. This may help you to solve the problem more quickly.
- Try to pinpoint the problem to avoid replacing non-defective parts.
- For example, if you replace batteries and the problem remains, put the original batteries back and go to the next step.
- Keep a record of the steps you take when troubleshooting. The information may be useful when calling for technical support or for passing on to service personnel.

Image Problems

Problem: No image appears on the screen

1. Verify the settings on your notebook or desktop PC.
2. Turn off all equipment and power up again in the correct order.
3. Check if shutter is enabled.

Problem: The image is blurred

1. Adjust the Focus on the projector.
3. Performance Auto Sync on the remote control or projector.
4. Ensure the projection distance is within the specified range.
5. Check that if the projection lens is clean.

Problem: The image is wider at the top or bottom (trapezoid effect)

1. Position the projector so it is as perpendicular to the screen as possible.
2. Use the Keystone function to correct the problem.

Problem: The image is reversed or upside down

Check the Projection Mode setting on the CONTROL->Projection Mode menu.

Problem: The image is streaked

1. Set the Total dots (H Total) and VGA Setup settings on the INPUT menu of the OSD to the default settings.
2. To ensure the problem is not caused by a connected PC's video card, connect to another computer.

Problem: The image is flat with no contrast

1. Adjust the Contrast setting on the PICTURE menu of the OSD.
2. Adjust the Brightness setting on the PICTURE menu of the OSD.

Problem: The color of the projected image does not match the source image.

Adjust the Color temperature and Gamma settings on the PICTURE menu of the OSD.

Projection Problems

Problem: There is no light from the projector

1. Check that the power cable is securely connected.
2. Ensure the power source is good by testing with another electrical device.
3. Restart the projector in the correct order and check that the Power LED is green.
4. Check if Blank or Shutter function is enabled

Remote Control Problems

Problem: The projector does not respond to the remote control.

1. Direct the remote control towards remote sensor on the projector.
2. Ensure the path between remote and sensor is not obstructed.
3. Check the remote sensor on OSD is turned on.
4. Ensure remote control wire is not plugged in the projector.
5. Turn off any fluorescent lights in the room.
6. Check the battery polarity.
7. Replace the batteries.
8. Turn off other Infrared-enabled devices in the vicinity.
9. Have the remote control serviced.
10. Ensure that the remote control code conforms to the projector's code if universal remote control is used.
11. Check if Projector ID control is enabled and the ID number is correct.

Projection Lens Problems

Problem: The Zoom or Focus adjustment cannot work.

1. Check if the lens is installed properly, improper lens installation may cause to lens cannot work normally. Please follow the lens installation procedure to check again.
2. Check if Lens Lock function is enabled, locking the lens will disable all of lens adjustment functions.
3. Perform Center Lens function to calibrate the Lens again.
4. Replace the other lens to check the problem if the lens is available.
5. Contact with service center for the details.

Remote communication Problems

Problem: The projector does not respond to Ethernet control

1. Make sure Network Standby is turned on, the communication path is interrupted if it's turned off (less 0.5W)
2. Check the network configuration in your laptop and projector; refer to Remote Communication manual for more information.

Having the Projector Serviced

If you are unable to solve the problem, you should have the projector serviced. Pack the projector in the original carton. Include a description of the problem and a checklist of the steps you took when trying to fix the problem. The information may be useful to the service personnel.

About the Vivitek Support

If you cannot find solutions from this user guideline, please contact us using the contact information below:

Europe, Middle East and Africa

Vivitek Service & Support

Zandsteen 15

2132 MZ Hoofddorp

The Netherlands

Tel: Monday - Friday 09:00 - 18:00

English (UK): 0333 0031993

Germany: 0231 7266 9190

France: 018 514 8582

Russian: +7 (495) 276-22-11

International: +31 (0) 20 721 9318

Email: support@vivitek.eu

URL: <http://www.vivitek.eu/support/contact-support>

North America

Vivitek Service Center

15700 Don Julian Road, Suite B

City of Industry, CA. 91745

U.S.A

Tel: 855-885-2378 (Toll-Free)

Email: T.services1@vivitekcorp.com

URL: www.vivitekusa.com

Asia and Taiwan

Vivitek Service Center

16 Tungyuan Rd., Chungli Industrial Zone,

Taoyuan City 320023, Taiwan

320023桃園市中壢區東園路16號4樓

Tel: 886-3-4526107

Tel: 0800-042-100

Email: srv-Service.VVK.Asia@vivitek.com.tw

URL: www.vivitek.com.tw

中国/China

Vivitek客服中心

上海市浦东新区华东路1675号1幢1层、7-8层

邮政编码: 201209

400客服热线: 400 888 3526

公司电话: 021-58360088

客服邮箱: service@vivitek.com.cn

官方网站: www.vivitek.com.cn



Visit www.vivitekc corp.com for more product info
Copyright (c) 2024 Delta Electronics, Inc. All Rights Reserved

A brand of  DELTA